



DEPARTMENT OF HEALTH AND HUMAN SERVICES  
DIVISION OF HEALTH SERVICE REGULATION

ROY COOPER  
GOVERNOR

MANDY COHEN, MD, MPH  
SECRETARY

MARK PAYNE  
DIRECTOR

September 29, 2017

Gary S. Qualls  
K&L Gates  
430 Davis Drive, Suite 400  
Morrisville, North Carolina 27560

**Exempt from Review – Replacement Equipment**

**Record #:** 2387  
**Facility Name:** Carolinas Medical Center (CMC)  
**FID #:** 943070  
**Business Name:** The Charlotte-Mecklenburg Hospital Authority  
**Business #:** 1770  
**Project Description:** Replace the existing unit of equipment at Carolinas Healthcare System (CHS) University that had been used to provide cardiac catheterization services by having a vendor remove it, rebuild it and install it in Room 1 at CMC to be used to provide EP services  
**County:** Mecklenburg

Dear Mr. Qualls:

The Healthcare Planning and Certificate of Need Section, Division of Health Service Regulation (Agency), determined that based on your letter of September 7, 2017, the above referenced proposal is exempt from certificate of need review in accordance with N.C. Gen. Stat. §131E-184(a)(7). Therefore, you may proceed to replace the existing unit of equipment at CHS University that had been used to provide cardiac catheterization services by having a vendor remove it, rebuild it and install it in Room 1 at CMC to be used to provide EP services. Please see the Agency's Material Compliance Approval letter dated September 29, 2017 regarding the change of site of one unit of cardiac catheterization equipment from CHS University to CMC.

Moreover, you need to contact the Agency's Construction and Acute and Home Care Licensure and Certification Sections to determine if they have any requirements for development of the proposed project.

It should be noted that the Agency's position is based solely on the facts represented by you and that any change in facts as represented would require further consideration by this office and a

**HEALTHCARE PLANNING AND CERTIFICATE OF NEED SECTION**

WWW.NCDHHS.GOV

TELEPHONE 919-855-3873

LOCATION: EDGERTON BUILDING • 809 RUGGLES DRIVE • RALEIGH, NC 27603

MAILING ADDRESS: 2704 MAIL SERVICE CENTER • RALEIGH, NC 27699-2704

AN EQUAL OPPORTUNITY/ AFFIRMATIVE ACTION EMPLOYER



separate determination. If you have any questions concerning this matter, please feel free to contact this office.

Sincerely,

*Gloria C. Hale*

Gloria C. Hale  
Project Analyst

*Martha J. Frisone*

Martha J. Frisone  
Chief, Healthcare Planning and  
Certificate of Need

cc: Construction Section, DHSR  
Acute and Home Care Licensure and Certification Section, DHSR  
Sharetta Blackwell, Program Assistant, Healthcare Planning, DHSR

*Correct date  
mt*

September 7, 2017



Gary S. Qualls  
D 919.466.1182  
F 919.516.2182  
gary.qualls@klgates.com

**Via Hand Delivery**

Martha J. Frisone, Chief  
Healthcare Planning and Certificate of Need Section  
Division of Health Service Regulation  
N.C. Department of Health and Human Services  
809 Ruggles Drive  
Raleigh, NC 27603



Dear Martha:

The Charlotte-Mecklenburg Hospital Authority (“CMHA”) d/b/a Carolinas Medical Center (“CMC”) and d/b/a CHS University seeks the two rulings described below. The Material Compliance Request in Part I merely asks to assign the Cardiac Catheterization (“Cardiac Cath”) CON Rights from one existing CMHA Equipment Unit to another (not increasing CMHA’s Cardiac Cath Unit complement). The Exemption Notice in Part II then describes how CMHA will take one of its existing electrophysiology (“EP”) Equipment Units and physically replace it with another existing, comparable CMHA EP Equipment Unit. A summary of each step is described immediately below. A more detailed description of each step is provided in Parts I and II below.

**Summary of Step #1**

1. CMHA seeks a material compliance determination to relocate the Cardiac Catheterization Equipment Unit CON Rights CMHA currently has for the University Campus Cardiac Cath Unit to an existing EP Unit currently housed in Cardiology Room 8 (“Room 8”) at CMC. That existing EP Unit in CMC Room 8 will become CMHA’s New Cardiac Cath Unit to supplant the old University Campus Cardiac Cath Unit. This will effectively be the substitution of the Cardiac Cath CON rights from one of CMHA’s current equipment units to another of CMHA’s current equipment units. This is couched as a material compliance request instead of a replacement equipment exemption because the equipment to be used as Cardiac Cath Equipment in CMC Room 8 is not being “purchased.” See N.C. Gen. Stat. 131E-176(22a).

**Summary of Step #2**

2. In Step #2, CMHA seeks a replacement equipment exemption to replace the Old University Campus Cardiac Cath Unit (which -- after Step #1 -- will no longer be a Cardiac Cath Unit with Cardiac Cath CON Rights) and replace it with an EP Unit at CMC in Cardiology Room 1 ("Room 1") for under \$2 Million (CMC Room 1 currently houses no medical equipment).

**I. Step #1 -- The Material Compliance Request.**

As described above, CMHA first seeks a material compliance determination to relocate the Cardiac Cath CON Rights currently assigned to the University Campus Cardiac Cath Unit to an existing EP Unit in CMC Room 8. That existing EP Unit in CMC Room 8 will become CMHA's New Cardiac Cath Unit to supplant the old University Campus Cardiac Cath Unit.<sup>1</sup> Since CMHA already owns the EP Unit in CMC Room 8 (to which the Cardiac Cath CON Rights are being assigned), this is a substitution of CON rights as opposed to a replacement equipment exemption. The equipment to be used as Cardiac Cath Equipment in CMC Room 8 is not being purchased, and thus does not trigger the replacement equipment definition under N.C. Gen. Stat. 131E-176(22a).

We have included floor plans showing the following:

- Exhibits 1A and 1B show macro and micro views of where the University Campus Cardiac Cath Unit is situated.
- Exhibits 2A, 2B, and 2C show macro and micro views of CMC Room 8, which will now house CMHA's New Cardiac Cath Unit.

There is precedent for the relocation of Cardiac Cath Equipment and associated CON Rights from one wholly owned hospital to another wholly owned hospital in the same county (and thus the same Cardiac Cath Service Area). In an August 5, 2015 material compliance determination, the Agency approved Novant Health to relocate and replace a Cardiac Cath Unit from Novant Health Presbyterian Medical Center ("Presbyterian") to Novant Health Matthews Medical Center ("Matthews"). See Exhibit 3.

---

<sup>1</sup> This New Cardiac Cath Unit will be the 8th Cardiac Cath Unit on the CMC Campus and will be the 9th Cardiac Cath Unit under CMC's license (given that one Cardiac Cath Unit on the CMC license is housed on the Mercy Campus). After this transaction is effectuated, the University Campus will no longer house any Cardiac Cath Units.

In requesting the relocation, Novant pointed out that both Presbyterian and Matthews were within the Novant Health corporate family and were both located in Mecklenburg County (and thus the same Cardiac Cath Service Area). See Exhibit 4.

That analysis fits CMHA here even better than it fit Novant in the foregoing scenario. In the Novant situation, Presby and Matthews were owned by two separate Novant Health subsidiaries, but were under Novant Health ownership at the parent level. Here, CMC and CHS University are both operating units of CMHA and are both located in Mecklenburg County. Thus, CMC and CHS University are operated within the same entity.

Thus, neither the substitution component nor the relocation component of this material compliance project is CON reviewable.

## **II. Step #2 -- The Replacement Equipment Exemption.**

As also described above, CMHA next seeks (in Step #2) a replacement equipment exemption to replace the physical piece of equipment that was formerly used as the University Campus Cardiac Cath Unit (the “Old University Cath Unit” or the “Existing Equipment”). CMHA will replace the Existing Equipment with an EP Unit at CMC in Room 1 for under \$2 Million (CMC Room 1 currently houses no medical equipment).

After Step #1 above, the Old University Cath Unit loses its status as “Cardiac Catheterization Equipment” under N.C. Gen. Stat. 131E-176(2f) and thus no longer has CON Rights to perform “Cardiac Catheterization Services under N.C. Gen. Stat. 131E-176(2g). Thus, after Step #1, the Old University Cath Unit will be stripped of its Cardiac Cath CON Rights and will now be comparable to the New EP Equipment in CMC Room 1 because the remaining capabilities of the Old University Cath Unit are now limited to EP (and other angiographic capabilities) as opposed to Cardiac Cath Services capabilities pursuant to Cardiac Cath CON Rights. Exhibits 5A and 5B show macro and micro views, respectively, of CMC Room 1, which will now house CMHA’s Replacement EP Unit.

**A. Section 184(a)(7) Exemption**

The General Assembly has chosen to exempt certain, otherwise reviewable events from CON review. Among those exemptions is the acquisition of “replacement equipment,” as provided in N.C. Gen. Stat. § 131E-184(a)(7), set forth below:

- (a) Except as provided in subsection (b), the Department shall exempt from certificate of need review a new institutional health service if it receives prior written notice from the entity proposing the new institutional health service, which notice includes an explanation of why the new institutional health service is required, for any of the following:

\* \* \*

- (7) To provide replacement equipment.

The CON Law then defines “replacement equipment,” as follows:

“Replacement equipment” means equipment that costs less than two million dollars (\$2,000,000) and is purchased for the sole purpose of replacing comparable medical equipment currently in use which will be sold or otherwise disposed of when replaced.

See N.C. Gen. Stat. § 131E-176(22a).

Therefore, to qualify for this exemption, the replacement equipment must cost less than \$2 Million and be “comparable” to the equipment it replaces and must be “sold or otherwise disposed of when replaced.” As described below, CMHA’s proposal qualifies for this exemption.

**B. Comparable Equipment**

The CON rule codified as 10A N.C.A.C. 14C.0303 (the “Regulation”) defines “comparable medical equipment” in Subsection (c) as follows:

“Comparable medical equipment” means equipment which is functionally similar and which is used for the same diagnostic or treatment purposes.

10A N.C.A.C. 14C.0303(c).

CMHA intends to use the Replacement Equipment for substantially the same types of treatments for which the Existing Equipment will be capable after Step #1 is consummated. As described above, after Step #1, the Old University Cath Unit will be comparable to the New EP Equipment in CMC Room 1 because the remaining capabilities of the Old University Cath Unit are now limited to EP (and other angiographic capabilities) as opposed to Cardiac Cath Services capabilities pursuant to Cardiac Cath CON Rights. The Replacement Equipment is therefore “comparable medical equipment” as defined in Subsection (c) of the Regulation.

Furthermore, CMHA does not intend to increase patient charges or per procedure operating expenses within the first 12 months after its acquisition. For further equipment comparison, please refer to Exhibit 9, the Equipment Comparison Chart.

Subsection (d) of the Regulation further provides that the Replacement Equipment is comparable to the Existing Equipment if:

- (1) the Replacement Equipment has the same technology as the Existing Equipment, although it may possess expanded capabilities due to technological improvements;
- (2) the Replacement Equipment is functionally similar and is used for the same diagnostic or treatment purposes as the Existing Equipment and is not used to provide a new health service; and
- (3) acquisition of the Replacement Equipment does not result in more than a 10% increase in patient charges or per procedure operating expenses within the first twelve months after the Replacement Equipment is acquired.

10A N.C.A.C. 14C.0303(d).

The Replacement Equipment will meet all three of the tests set out in Subsection (d). The Replacement Equipment satisfies the technology and functionality tests in Subsection (1) and (2) as discussed above and identified in the Comparison Chart. See Exhibit 9. Moreover, CMHA represents that use of the Replacement Equipment will not result in the types of expense or charge increase described in Subsection (d)(3).

**C. Cost of the Replacement Equipment**

The total costs are \$1,962,116.59 to acquire, install, and make operational the Replacement EP Unit (the "Replacement Equipment") and all items to be placed in CMC Room #1. The line item component costs are set forth in Exhibit 6 (Proposed Total Capital Cost Sheet). The Quote for the Replacement Equipment by itself is attached as Exhibit 7. The Quotes for other equipment items to be placed in Room #1 are included in Exhibit 8.

Thus, the costs are less than the \$2 Million threshold in N.C. Gen. Stat. § 131E-176(22a), even if one counts all items to be placed in CMC Room #1 and the related construction costs.

**D. Equipment Being Replaced is Currently in Use**

The Existing Equipment is currently in use at CHS University, identified as the University Campus Cardiac Cath Unit described in detail in Part I above.

**CONCLUSION**

Based on the foregoing information, CMHA asks the Agency to make the following two rulings:

1. Find that assigning the Cardiac Cath CON Rights from one existing CMHA Equipment Unit to another (not increasing CMHA's Cardiac Cath Unit complement) materially complies with the CON for the CHS University Cardiac Cath Unit.
2. Find that the replacement equipment transaction described in Part II above is exempt from CON review under N.C. Gen. Stat. § 131E-184(a)(7).

We thank you for your consideration of this notice.

Sincerely,

  
Gary S. Qualls



**Exhibits**

- 1A. Macro view of University Campus Cardiac Cath Unit
- 1B. Micro view of University Campus Cardiac Cath Unit
- 2A. Macro view of CMC Room 8, which will now house CMHA's New Cardiac Cath Unit.
- 2B. Micro view of CMC Room 8, which will now house CMHA's New Cardiac Cath Unit.
- 2C. Enlarged micro view of CMC Room 8, which will now house CMHA's New Cardiac Cath Unit.
3. August 5, 2015 Material Compliance Letter approving Novant Health to relocate and replace a Cardiac Cath Unit from Novant Health Presbyterian Medical Center to Novant Health Matthews Medical Center.
4. July 16, 2015 Request by Novant Health to relocate and replace a Cardiac Cath Unit from Novant Health Presbyterian Medical Center to Novant Health Matthews Medical Center.
- 5A. Macro views of CMC Room 1, which will now house CMHA's Replacement EP Unit.
- 5B. Micro views of CMC Room 1, which will now house CMHA's Replacement EP Unit.
6. Proposed Total Capital Cost Sheet for CMC Room 1
- 7A. EP Replacement Equipment Quote
- 7B. EP Replacement Equipment Brochure
- 7C. EP Replacement Equipment Brochure

Martha J. Frisone, Chief  
September 7, 2017  
Page 8

8. Other Equipment Quotes for Items to be placed in CMC Room 1
  - 8A. Omnicell Items
  - 8B. Accriva Item
  - 8C. Surgical Light
  - 8D. Stryker Items
9. Equipment Comparison Chart

**COLOR KEY**

- EXISTING BUILDING
- RENOVATION

PROJECT AREA

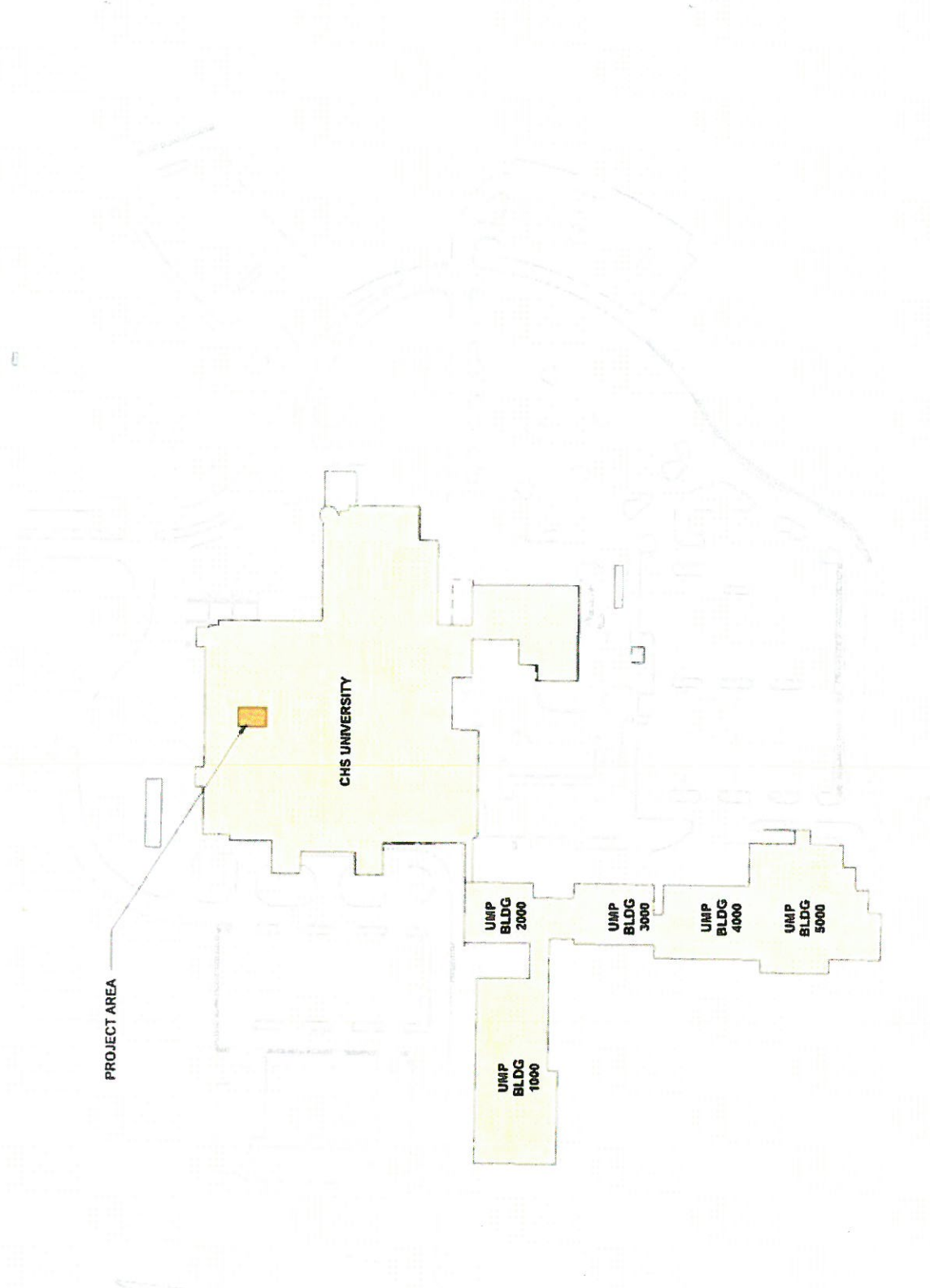

**CHS UNIVERSITY**

Carolinas HealthCare System

08/18/2017

**SITE PLAN**

Cardiac Cath Lab

**EXHIBIT**

1A

Robber



COLOR KEY

EXISTING BUILDING

RENOVATION

EXISTING CARDIAC  
CATH LAB

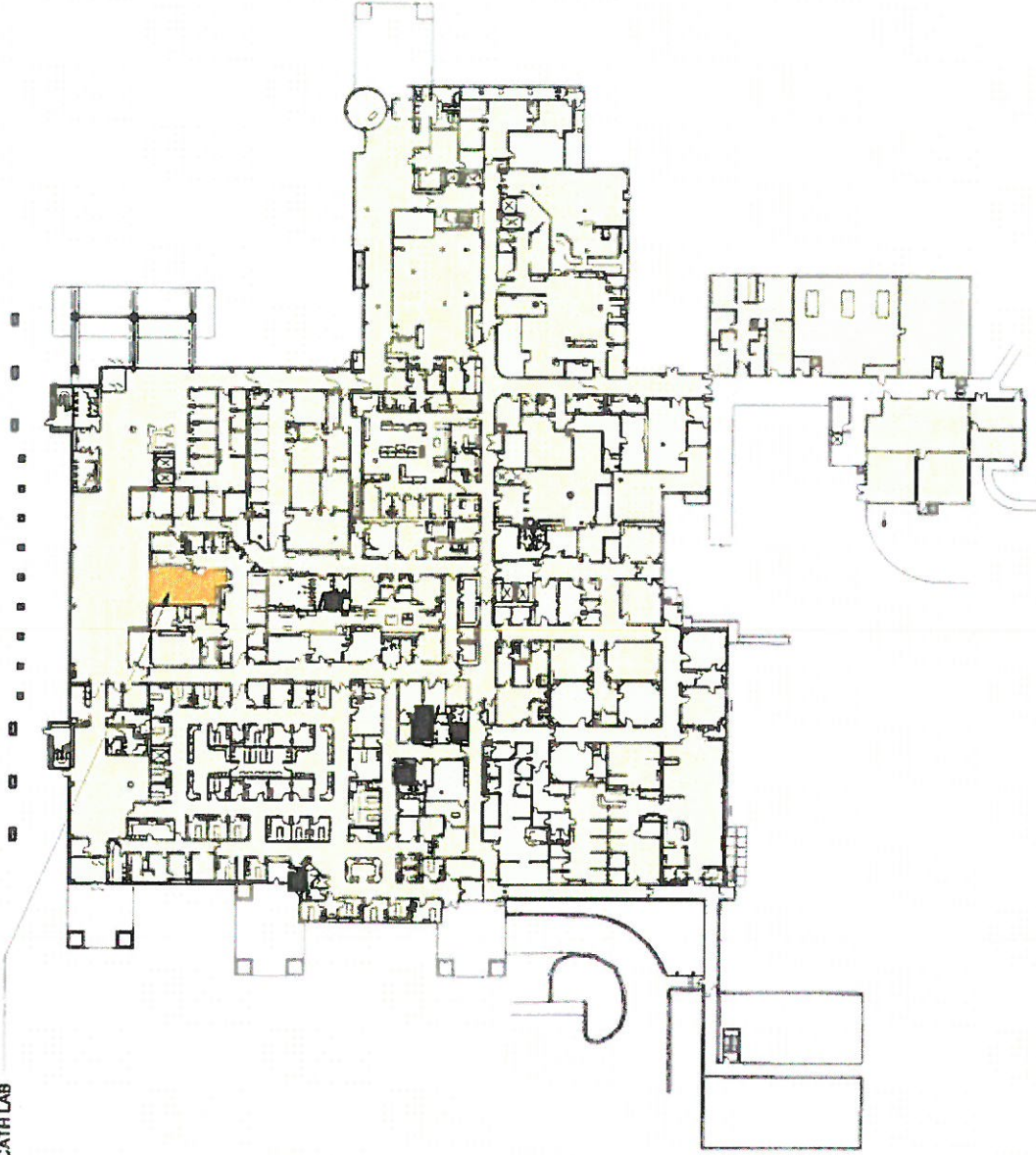

CHS UNIVERSITY

Carolinas HealthCare System

08/18/2017

EXISTING PLAN - LEVEL 01

Cardiac Cath Lab





EXHIBIT

1B

booklet



**COLOR KEY.**

-  EXISTING BUILDING
-  PROJECT UNDER CONSTRUCTION
-  RENOVATION
-  UNDERGROUND

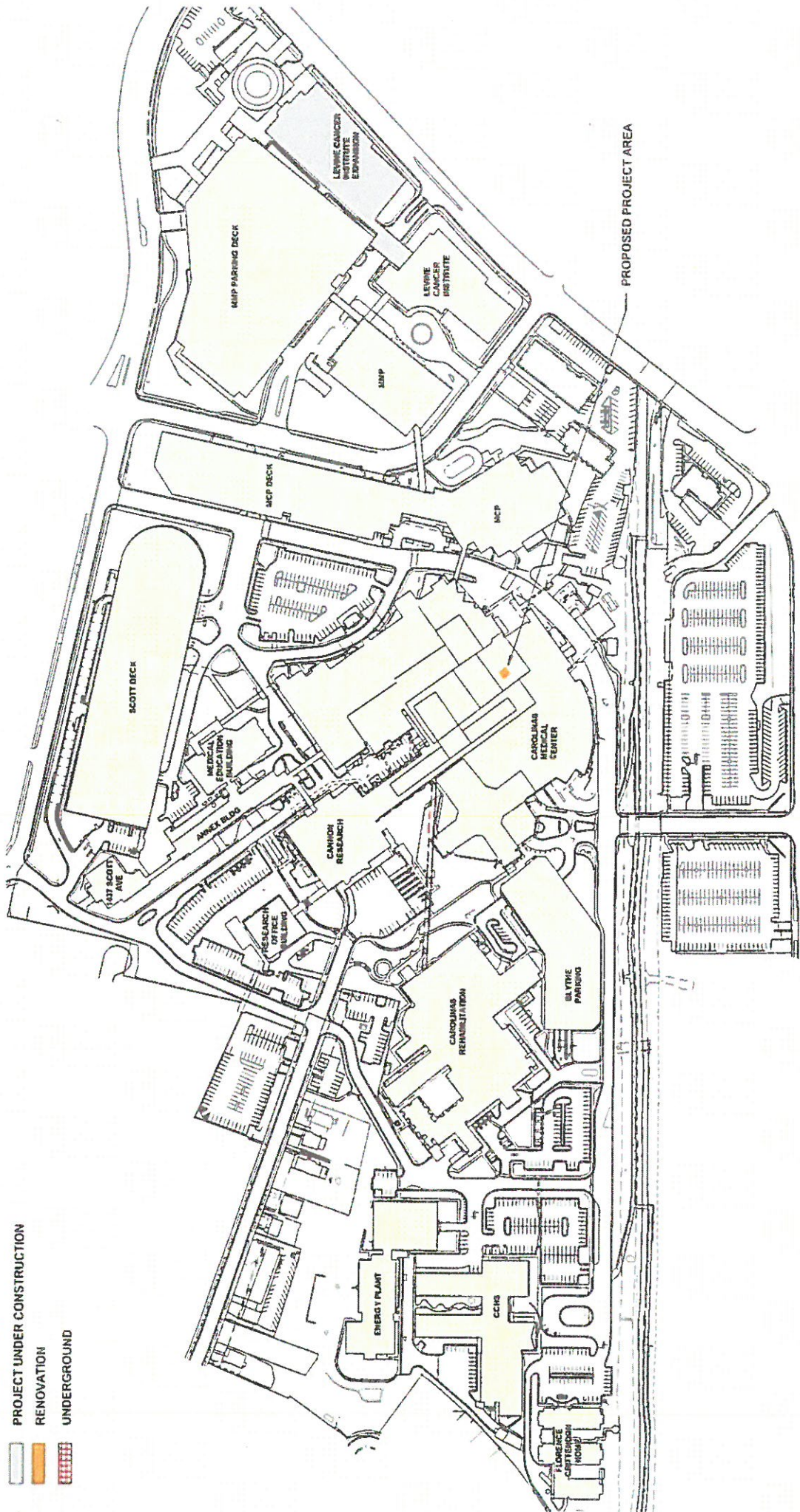

**CAROLINAS MEDICAL CENTER**

Carolinas HealthCare System

**SITE PLAN**

Cardiac Cath Lab



08/18/2017

**EXHIBIT**  
 2A

**COLOR KEY**

EXISTING BUILDING

RENOVATION

Current Room #	Specialty	Licensed
1	Treatment Room	No
2	EP/AV/Cath	Yes
3	Cath	Yes
4	Cath	Yes
5	Cath	Yes
6	PV	No
7	EP	Yes
8	EP/SHA	No

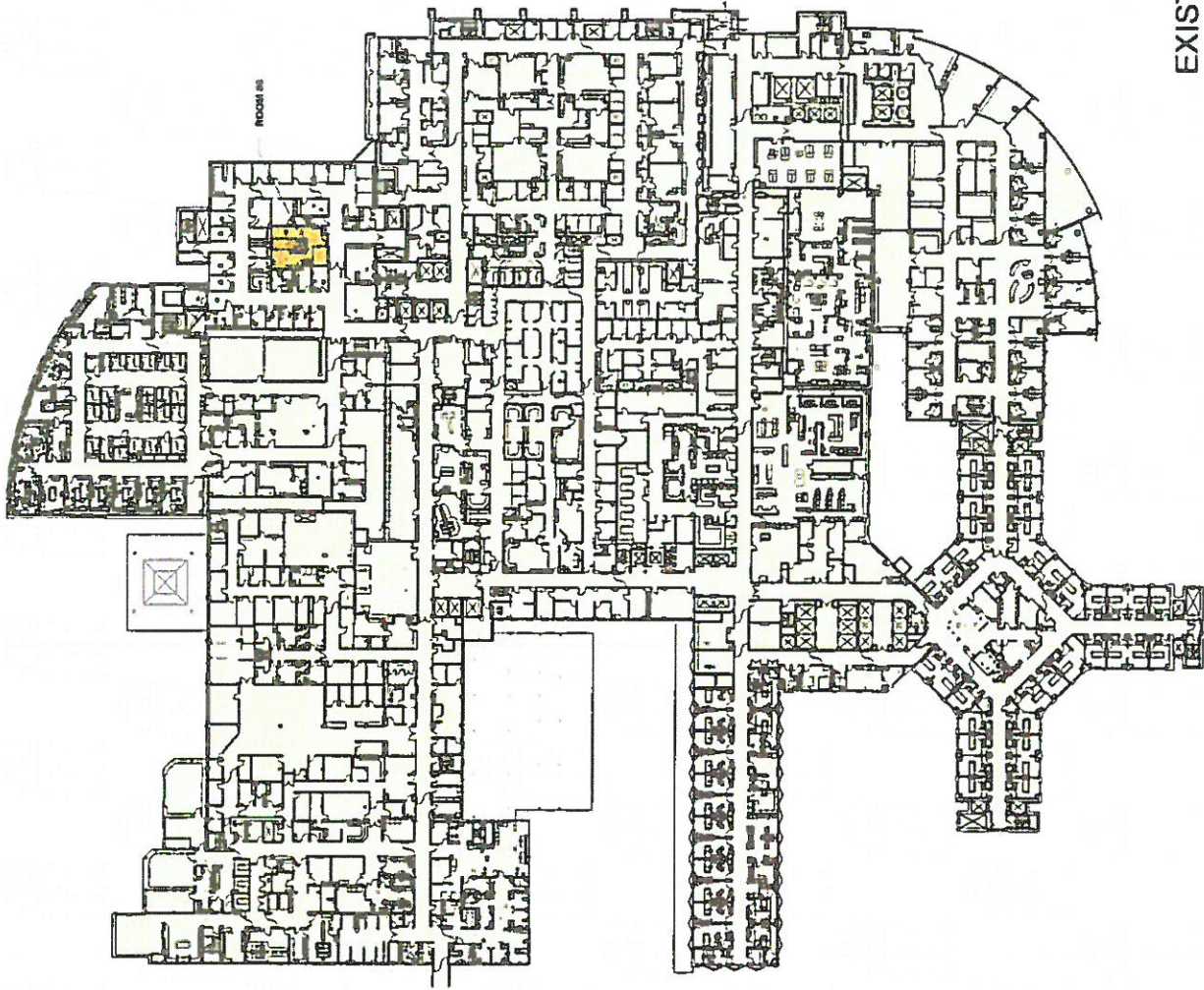

CAROLINAS MEDICAL CENTER

Carolinas HealthCare System

EXISTING PLAN- LEVEL 04

Cardiac Cath Lab



EXHIBIT

26

Booklet

08/18/2017

**COLOR KEY**

- EXISTING BUILDING
- RENOVATION

FUTURE		Specialty	Licenses
Room #			
1		EP	No
2		PV/Cath	Yes
3		Cath	Yes
4		Cath	Yes
5		Cath	Yes
6		PV	No
7		EP	Yes
8		EP/SH/Cath	Yes

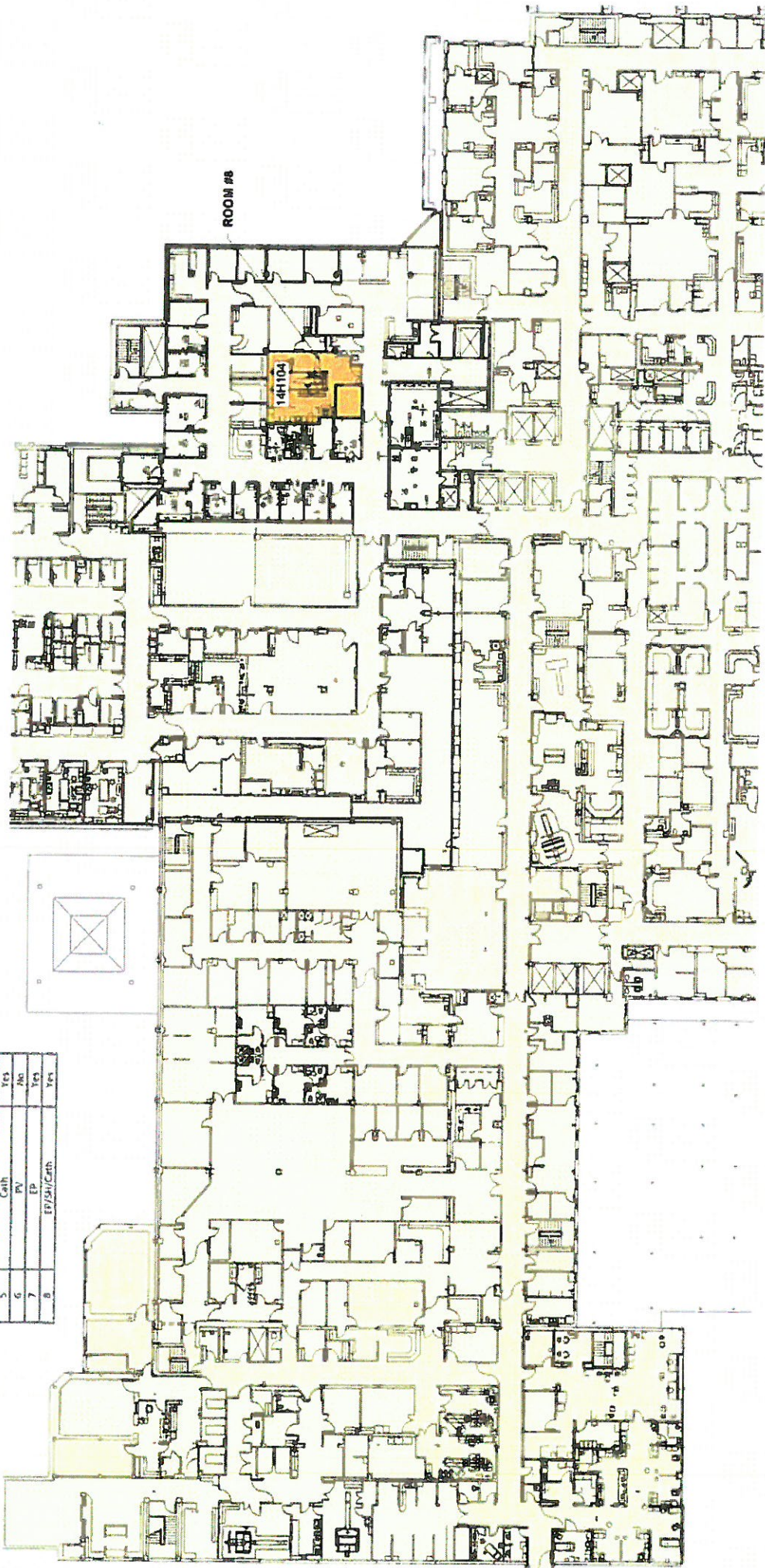

**CAROLINAS MEDICAL CENTER**

Carolinas HealthCare System

**ENLARGED PROPOSED PLAN - LEVEL 04**



Cardiac Cath Lab

EXHIBIT

20

bbctier

08/18/2017

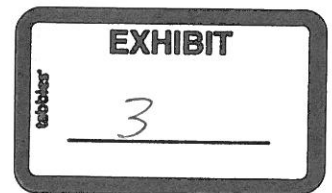

North Carolina Department of Health and Human Services  
Division of Health Service Regulation

Pat McCrory  
Governor

Aldona Z. Wos, M.D.  
Ambassador (Ret.)  
Secretary DHHS

Drexdal Pratt  
Division Director

August 5, 2015

Barbara L. Freedy  
Certificate of Need  
Novant Health, Inc.  
2085 Frontis Plaza Drive  
Winston-Salem, North Carolina 27103

**Material Compliance Approval**

Project ID #: F-001810-83  
Facility: Novant Health Presbyterian Medical Center (NHPMC)  
Project Description: Locate replacement cardiac catheterization equipment at Novant Health  
Matthews Medical Center (NHMMC)  
County: Mecklenburg  
FID #: 943501

Dear Ms. Freedy:

The Healthcare Planning and Certificate of Need Section, Division of Health Service Regulation (Agency) has determined that the change proposed in your letter of July 9, 2015 is in material compliance with representations made in the application. This change includes relocating a cardiac catheterization lab from NHPMC's cardiac catheterization lab #1 to NHMMC. Both facilities are in the Mecklenburg County service area. However, you should contact the Agency's Construction Section to determine if they have any requirements pertinent to the proposed change.

It should be noted that the Agency's position is based solely on the facts represented by you, including supplemental information provided to the Agency in an additional letter, dated July 9, 2015, regarding NHMMC's ability to safely perform interventional cardiac catheterization procedures, and that any change in facts as represented would require further consideration by this office and a separate determination.

If you have any questions concerning this matter, please feel free to contact this office. Please refer to the Project ID # and Facility ID # (FID) in all correspondence.

**Healthcare Planning and Certificate of Need Section**

[www.ncdhhs.gov](http://www.ncdhhs.gov)

Telephone: 919-855-3873 • Fax: 919-715-4413

Location: Edgerton Building • 809 Ruggles Drive • Raleigh, NC 27603

Mailing Address: 2704 Mail Service Center • Raleigh, NC 27699-2704

An Equal Opportunity/ Affirmative Action Employer





Barbara L. Freedy  
August 5, 2015  
Page 2

Sincerely,



Gloria C. Hale  
Project Analyst



Martha J. Frisone,  
Assistant Chief, Certificate of Need

cc: Construction Section, DHSR  
Acute and Home Care, Licensure and Certification Section, DHSR  
Assistant Chief, Healthcare Planning

# Nelson Mullins

Nelson Mullins Riley & Scarborough LLP  
Attorneys and Counselors at Law  
380 Knollwood Street / Suite 530 / Winston-Salem, NC 27103  
Tel: 336.774.3300 Fax: 336.774.3372  
www.nelsonmullins.com

Denise M. Gunter  
Tel: 336.774.3322  
Fax: 336.774.3372  
denise.gunter@nelsonmullins.com

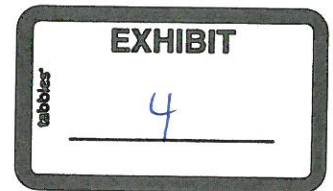

July 16, 2015

## Hand Delivered

Martha J. Frisone, Assistant Chief  
North Carolina Department of Health and Human Services  
Division of Health Service Regulation  
Certificate of Need and Health Planning Section  
809 Ruggles Drive  
Raleigh, North Carolina 27603

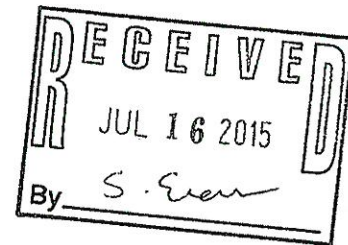

Re: No Review Request for Novant Health, Inc., The Presbyterian Hospital d/b/a Novant Health Presbyterian Medical Center and Presbyterian Medical Care Corp. d/b/a Novant Health Matthews Medical Center  
Mecklenburg County  
Health Service Area III

Dear Ms. Frisone:

On behalf Novant Health, Inc. ("Novant"), The Presbyterian Hospital d/b/a Novant Health Presbyterian Medical Center ("NHPMC") and Presbyterian Medical Care Corp. d/b/a Novant Health Matthews Medical Center ("NHMMC"), I am writing to request written confirmation that the CON Law does not apply to the following transaction (the "Transaction").

## ***Factual Background***

Novant is a nonprofit health care system that owns fourteen hospitals. Two of these hospitals are NHPMC and NHMMC. NHPMC and NHMMC are acute care hospitals located in Mecklenburg County, North Carolina. NHPMC and NHMMC are wholly-owned subsidiaries of Novant Health Southern Piedmont Region, LLC, a member-managed limited liability company whose sole member is Novant. See Exhibit A. Novant is therefore the ultimate parent entity of both NHPMC and NHMMC. NHPMC and NHMMC are affiliates within the Novant corporate family. See Exhibit B, 2014 audited financials for Novant, p. 6, note 1.

*Ex were disposed of  
and admin. value. closed*

NHPMC owns four units of fixed cardiac catheterization equipment. NHMMC presently provides both diagnostic and interventional cardiac catheterization services using equipment owned by a third party. See Tables 9S, 9V and 9W of the 2015 SMFP, attached hereto as Exhibit C.

### *The Transaction*

The contract with the third party ends in December 2015. Rather than continue to incur the cost of the contract, NHPMC proposes to move one of its four existing and operational cardiac catheterization units ("Cath Lab #1") to NHMMC. In separate correspondence to the CON Section, NHPMC and NHMMC request that the CON Section determine that the replacement of Cath Lab #1 qualifies for the replacement equipment exemption under N.C. Gen. Stat. § 131E-184(a)(7)(the "Replacement Cath Lab"). NHMMC has also submitted separate correspondence to the CON Section demonstrating that NHMMC can safely perform interventional cardiac catheterization procedures without open heart surgery services on site.<sup>1</sup> If the Transaction is approved, the Replacement Cath Lab would then be reported on NHMMC's annual Hospital License Renewal Application.

### *Analysis*

The CON Law applies to "new institutional health services." N.C. Gen. Stat. § 131E-178(a). N.C. Gen. Stat. § 131-176(16)f1. defines "new institutional health service" to include "the acquisition by purchase, donation, lease, transfer, or comparable arrangement" of certain types of medical equipment, including cardiac catheterization equipment. See N.C. Gen. Stat. § 131E-176(16)f1.3. For the reasons set forth below, this provision of the CON Law should not apply to the Transaction.

The Transaction involves a move between and among entities that are entirely within the Novant corporate family. Novant ultimately controls both NHPMC and NHMMC. No one outside of Novant is acquiring anything in this Transaction. Ultimately, all assets at NHPMC (including Cath Lab #1) and NHMMC are owned by Novant. As has been demonstrated through dozens of CONs applications filed throughout the years, the financials for these hospitals and all other Novant-controlled facilities are consolidated, and only one set of audited financials is produced for the entire Novant family, including NHPMC and NHMMC. See, e.g., Exhibit B, which are Novant's 2014 audited financials. As stated on page 6, note 2 of the 2014 audited financials: "[t]he consolidated financial statements include the accounts of all affiliates controlled by Novant Health." These affiliates include NHPMC and NHMMC. See *id.*, note 1. Further, when Novant issues bonds through the North Carolina Medical Care Commission, the proceeds are used to pay for projects at various

---

<sup>1</sup> These additional letters are incorporated by reference in this letter.

Martha J. Frisone  
July 16, 2015  
Page 3

Novant-owned facilities, including NHPMC and NHMMC. Regarding bonds issued in 2013, page 32 of the 2014 audited financials reports:

[t]he remaining proceeds [of the 2013 issue] were used to finance and reimburse Novant Health for expenditures primarily related to the construction of the following. . . . the vertical expansion of Novant Health Matthews Medical Center; . . . and the G-wing renovation at Novant Health Presbyterian Medical Center.

Exhibit B, p. 32

There will be no increase in the inventory of cardiac catheterization equipment in Mecklenburg County beyond those units which have already been approved. No new health service facilities or services are being added beyond those already approved. Rather, the Transaction should be regarded merely as a reorganization similar to those which the CON Section and the Department have previously determined are not subject to CON review.

For example, in 2011, CSA Medical Services, LLC ("CSA") proposed to transfer its interest in eight existing heart lung bypass machines to two wholly-owned subsidiary limited liability companies, CSAMS New Bern Avenue, LLC and CSAMS Lake Boone Trail, LLC. See Exhibit D. Five of the machines were located at WakeMed, and three of the machines were located at Rex.

In its no review request, CSA pointed out that 10A NCAC 14C.0502(b) allows for the transfer of *undeveloped* CONs in cases of corporate reorganizations. See Exhibit D, page 4. CSA further stated that ". . . [i]f the CON law permits the transfer of a CON for an undeveloped project to a subsidiary of the applicant without a new CON or other sanction, then it would make no sense to interpret the law to prevent an existing provider from transferring a service to a wholly-owned subsidiary after the project has been developed." *Id.* CSA also relied upon N.C. Gen. Stat. § 131E-189(c):

[m]oreover, N.C. Gen. Stat. § 131E-189(c) acknowledges that completed projects may be transferred without CON review. It states that '[a]ny transfer after [the project is completed or becomes operational] will be subject to the requirement that the service be provided consistent with the representations made in the application and any applicable conditions.' That statute does not require that a CON first be acquired before such a transfer takes place. Clearly, the reorganization of CSA's assets and CON exemption into two wholly owned subsidiaries would not constitute the 'offering or development of a new institutional

health service' within the definition of N.C. Gen. Stat. § 131E-178(a).

*Id.*, p. 4. The CON Section determined that the CON Law did not govern CSA's proposal. See Exhibit E.<sup>2</sup>

The CSA decision applies here. Cath Lab #1 is an existing and operational cath lab. While NHMMC is not a subsidiary of NHPMC, these two hospitals are corporate affiliates within the Novant corporate family, and are subsidiaries of the same entity (Novant Health Southern Piedmont Region) which is in turn wholly owed by Novant. Ultimately, Novant owns and controls Cath Lab #1, and that will not change as a result of this Transaction. It would not serve the purposes of the CON Law to require regulatory review of an existing cath lab that is being moved from one corporate affiliate to another in Mecklenburg County. Further, both diagnostic and interventional cardiac catheterization services have been provided for years at NHMMC; thus, the need for the service has already been established. It would not make sense for NHMMC to have to reprove the need for a service it already offers.

The CSA no review also included the 2011 Radiation Oncology Centers of the Carolinas, Inc. ("ROCC") declaratory ruling (included in Exhibit D), which permitted ROCC to transfer its interests in two radiation oncology facilities owning linear accelerators to two wholly-owned subsidiaries of ROCC. In a more recent, analogous declaratory ruling, the Department permitted Caldwell Memorial Hospital, a subsidiary of UNC Health Care, to "redesignate" its cancer center space, including a linear accelerator, to unlicensed space of its sister hospital, UNC Hospitals. See Exhibit G, a March 12, 2015 declaratory ruling issued to UNC Healthcare System, UNC Hospitals and Caldwell Memorial. In the UNC/Caldwell declaratory ruling, the Department stated:

Nor does the Redesignation of the Cancer Center Space trigger any of the 'acquisition-related' new institutional health service definitions in N.C. Gen. Stat. § 131E-176(16). The Cancer Center Space, the Radiation Oncology Equipment, and the Medical Oncology Equipment are not being acquired, because no legal entity outside of the UNC Health Care controlled affiliates is acquiring anything. Rather, this Redesignation is purely an intra-organizational Redesignation within UNC Health Care controlled affiliates. See 10A NCAC 14C.0502.

---

<sup>2</sup> Subsequently, Rex was permitted to acquire the membership interests in CSAMS Lake Boone Trail, and WakeMed was permitted to acquire the membership interests in CSAMS New Bern Avenue. See Exhibit F. No third party outside the Novant corporate family is involved in the Transaction.

\*\*\*

This Redesignation does not involve the offering or expansion of any new facility, service or equipment, and the inventory of linear accelerators and CT scanners in Caldwell County and the State overall will not change. No new radiation oncology equipment or services will be placed in operation in Caldwell County or the State as a result of this Project.

Exhibit G, p. 7.

The UNC/Caldwell ruling applies here. No legal entity outside of Novant will be acquiring anything in the Transaction. The Transaction is purely intra-organizational. The Transaction does not involve the offering or expansion of any new facility, service or equipment, and neither the inventory of cardiac catheterization labs in Mecklenburg County nor the State overall will change as a result of the Transaction. No new cardiac catheterization equipment or services will be placed in operation in Mecklenburg County or the State as a result of this Transaction.<sup>3</sup>

As the UNC/Caldwell ruling aptly recognized,

[i]t is a well-established principle of statutory construction that the intent of the Legislature controls the interpretation of the statute. *See State v. Fulcher*, 294 N.C. 503, 520, 2432 S.E.2d 338, 350 (1978). Prohibiting this simple intra-organizational Redesignation of existing services would not advance the goal of avoiding costly duplication because the Radiation Oncology Equipment and the Cancer Center Space already exist and are used to provide the same services they will provide after the Redesignation. Construing the statute otherwise would lead to absurd results that the General Assembly could not have intended. *King v. Baldwin*, 276 N.C. 316, 325, 172 S.E.2d 12, 18 (1970)('It is presumed that the legislature acted in accordance with reason and common sense and that it did not intend an unjust or absurd result.').

Exhibit G, p. 7.

---

<sup>3</sup> As discussed in separate correspondence filed with the CON Section, NHMMC intends to replace the nineteen-year old Cath Lab #1 with the Replacement Cath Lab. The proposed replacement, which is exempt under N.C. Gen. Stat. § 131E-184(a)(7), does not increase the inventory of cath labs in Mecklenburg County or the State overall.

Martha J. Frisone  
July 16, 2015  
Page 6

The same is true here. The Transaction is not the sort of acquisition the CON Law seeks to regulate. Cath Lab #1 is existing equipment owned by a common parent. It will be used to provide the same services at NHMMC that it provides at NHPMC. Under these circumstances, the Transaction should not be deemed subject to CON review under N.C. Gen. Stat. § 131E-176(16)f1.3. *See also Cape Fear Memorial Hospital v. N.C. Dep't of Human Resources*, 121 N.C. App. 492, 494, 466 S.E.2d 299, 301 (1996) (holding that the legislature clearly did not intend to impose unreasonable limitations on maintaining, or expanding, presently offered health services).

Similarly, the Transaction does not implicate N.C. Gen. Stat. § 131E-176(16)b., requiring CON review for a capital expenditure greater than \$2 million "to develop or expand a health service or a health service facility, or which relates to the provision of a health service." As discussed in the companion Replacement Equipment Exemption Request, the total cost to replace Cath Lab #1, including disposal of Cath Lab #1, is \$922,524.

Finally, the relocation of Cath Lab #1 from Charlotte to Matthews is not reviewable under the CON Law. Both hospitals are in Mecklenburg County. They are approximately 11 miles and 16 minutes apart from each other. *See Exhibit H*, a Mapquest map. The Department has previously approved relocations of equipment within Mecklenburg County that involved similar or greater distances. *See, e.g., Exhibit I* (November 13, 2006 ruling allowing Presbyterian to transfer an MRI scanner from Charlotte to Huntersville, a distance of approximately 15.44 miles); *Exhibit J* (March 3, 2008 ruling allowing Carolinas Imaging Services, LLC to relocate an MRI scanner from Huntersville to the Ballantyne area of Charlotte, a distance of approximately 31 miles); and *Exhibit K* (February 7, 2014 ruling allowing Presbyterian to change the location of an undeveloped linear accelerator from Matthews to Huntersville, a distance of approximately 25 miles).

Accordingly, Novant, NHPMC and NHMMC respectfully request that the CON Section determine that the Transaction described in this letter does not require CON review.

Thank you for your time and consideration.

Sincerely,

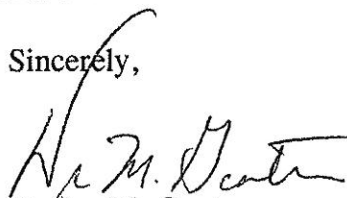

Denise M. Gunter

Enclosures

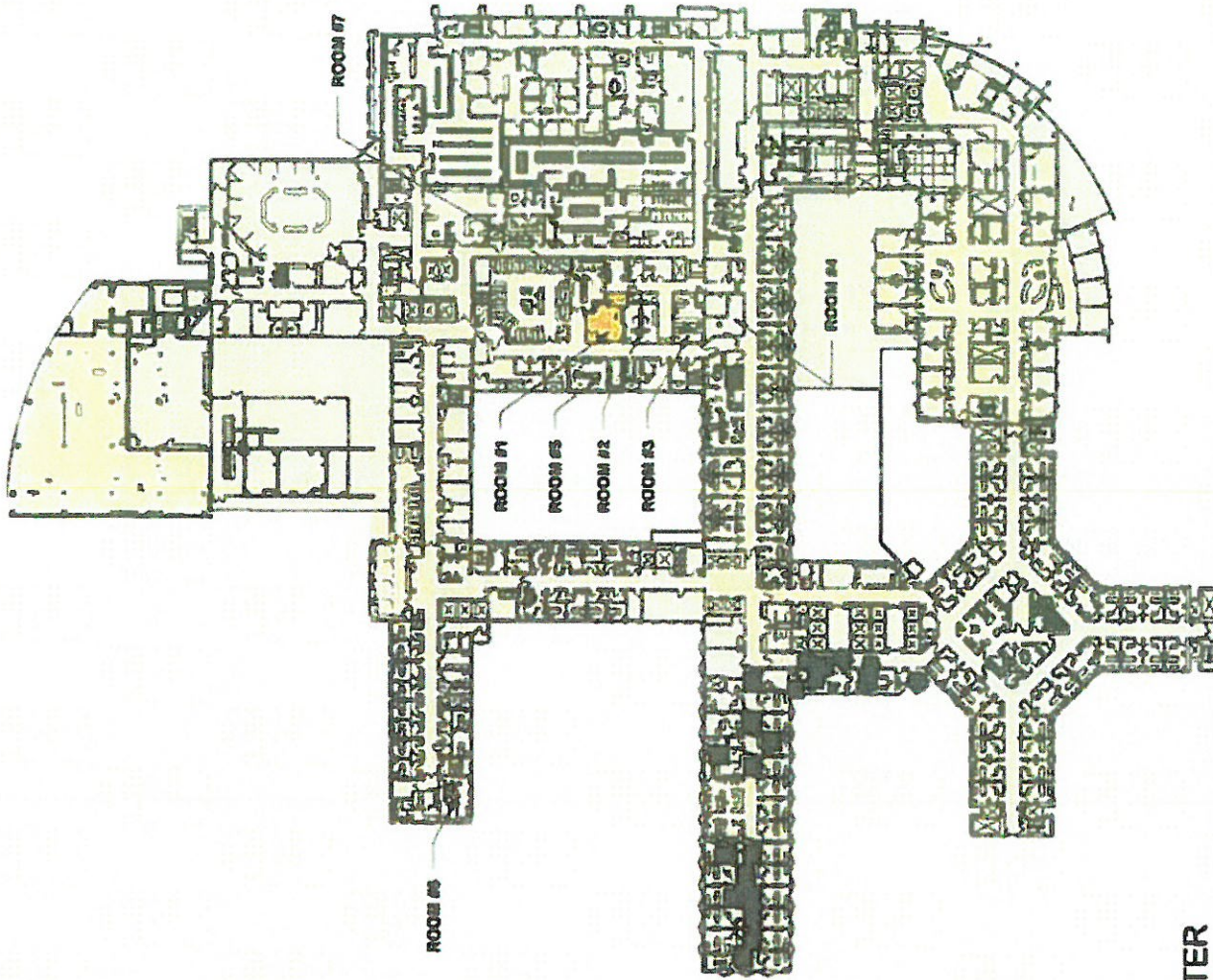

**COLOR KEY**

- EXISTING BUILDING
- RENOVATION

Current Room #	Specialty	Unbonded
1	Treatment Room	No
2	LPN/CNA	Yes
3	Cath	Yes
4	Cath	Yes
5	Cath	Yes
6	PV	No
7	EP	Yes
8	EP/AM	No

**CAROLINAS MEDICAL CENTER**

Carolinas HealthCare System

06/19/2017

**EXISTING PLAN- LEVEL 06**



**EXHIBIT**

5A

66005



**COLOR KEY**

- EXISTING BUILDING
- RENOVATION

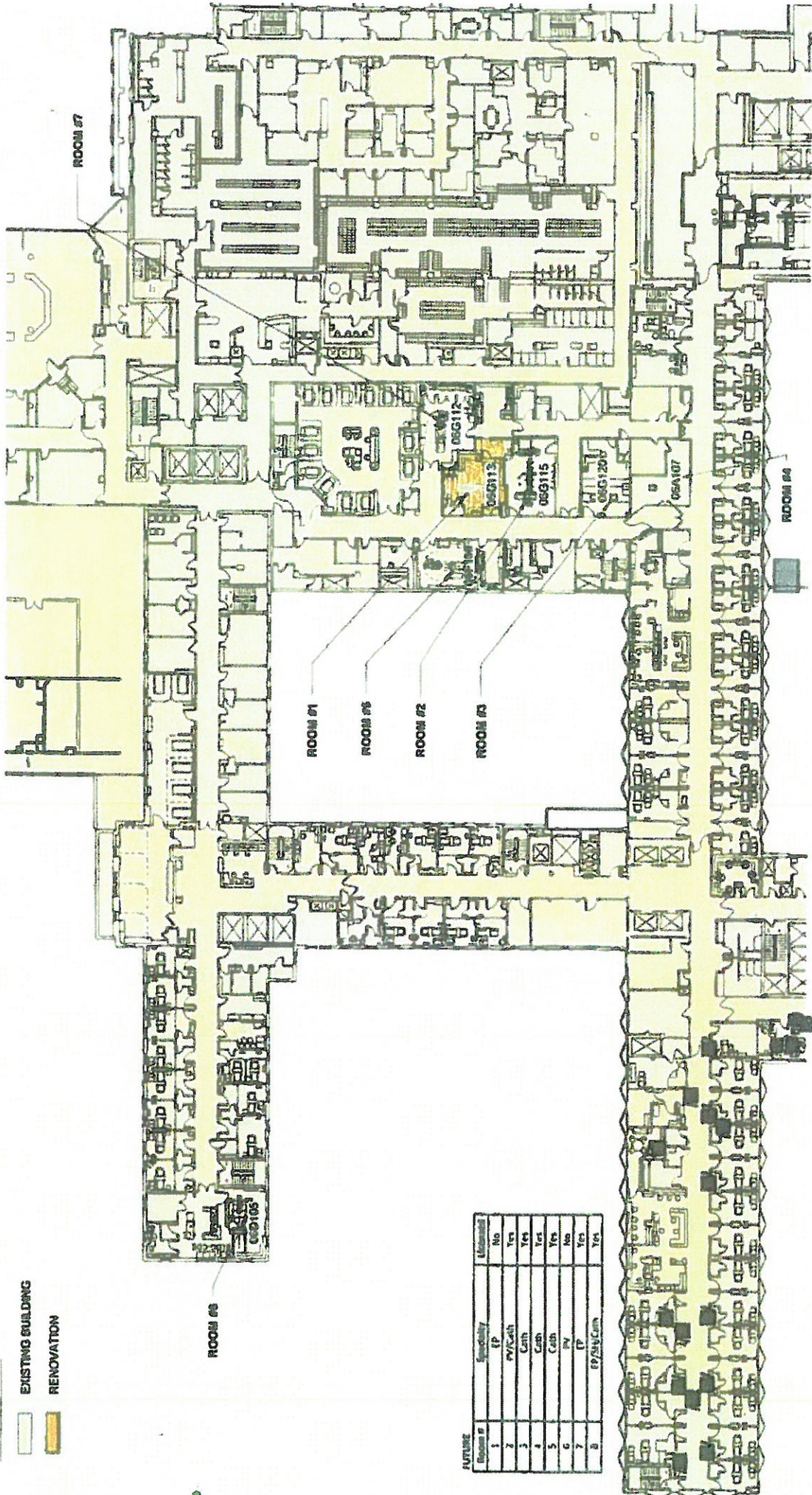

FUTURE	Room #	Specialty	Utilization
1	EP	No	No
2	PT/Cath	Yes	Yes
3	Cath	Yes	Yes
4	Cath	Yes	Yes
5	Cath	Yes	Yes
6	IV	No	No
7	EP	Yes	Yes
8	EP/Sup/Com	Yes	Yes

**CAROLINAS MEDICAL CENTER**

Carolinas HealthCare System

**ENLARGED PROPOSED PLAN-LEVEL 06**

03/16/2017

**EXHIBIT**

5B

Sublet



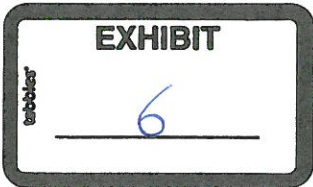

**PROPOSED TOTAL CAPITAL COST OF PROJECT**

**Project name:** Cardiac Cath Lab  
**Provider/Company:** Carolinas Healthcare System

(1) Purchase price of land	NA
(2) Closing costs	NA
(3) Site Preparation	NA
(4) Construction/Renovation Contract	\$522,917.00
(5) Landscaping	NA
(6) Architect/Engineering Fees	\$48,500.00
(7) Medical Equipment	\$1,235,707.84
(8) Non Medical Equipment	NA
(9) Furniture	\$5,760.00
(10) Consultant Fees (CON Fees, Legal Fees, Design Fees)	NA
(11) Financing Costs	NA
(12) Interest During Construction	NA
(13) Other (IS, Security, Internal Allocation)	\$149,231.75
(14) <b>Total Capital Cost</b>	<b>\$1,962,116.59</b>

*I certify that, to the best of my knowledge, the above construction related costs of the proposed project named above are complete and correct.*

A handwritten signature in black ink, appearing to read "T. W. M. O. W.", written over a horizontal line.

9/04/17

*(Signature of Licensed Architect or Engineer)*

*DATE*

Sales taxes have been included in these equipment costs. However, because CHS is entitled to a sales tax refund under N.C. Gen. Stat. § 105-164.14(b) and 105-467, the sales tax that CHS initially incurs for this medical equipment purchase will be refunded to CHS, and thus will reduce the capital costs that CHS actually incurs for the equipment by \$83,129.93.

**PHILIPS HEALTHCARE**  
A division of Philips North America LLC  
22100 Bothell Everett Highway  
P.O. Box 3003  
Bothell, Washington 98041-3003

# PHILIPS

<b>Quotation #:</b> 1-103XHZ1	<b>Rev:</b> 16	<b>Effective From:</b> 25-Jul-17	<b>To:</b> 15-Sep-17
<b>Presented To:</b> CAROLINA MEDICAL CENTER 1000 BLYTHE BLVD CHARLOTTE, NC 28203-5871  Tel:  <b>Alternate Address:</b>	<b>Presented By:</b> Brett Kimball <i>Account Manager</i>  John Hill <i>Regional Manager</i>	<b>Tel:</b> <b>Fax:</b>  <b>Tel:</b> (800) 722-7900 x6806 <b>Fax:</b>	
<b>Date Printed:</b> 18-Aug-17			
<b>Submit Orders To:</b> 22100 BOTHELL EVERETT HWY BOTHELL WA 98021  Tel: (888) 564-8643 Fax:(425) 458-0390			

This quotation contains confidential and proprietary information of Philips Healthcare, a division of Philips North America LLC ("Philips") and is intended for use only by the customer whose name appears on this quotation. It may not be disclosed to third parties without the prior written consent of Philips.

**IMPORTANT NOTICE:** Health care providers are reminded that if the transactions herein include or involve a loan or discount (including a rebate or other price reduction), they must fully and accurately report such loan or discount on cost reports or other applicable reports or claims for payment submitted under any federal or state health care program, including but not limited to Medicare and Medicaid, such as may be required by state or federal law, including but not limited to 42 CFR 1001.952(h).

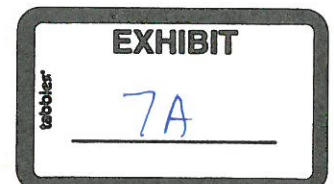

## Quote Solution Summary

<u>Line #</u>	<u>Product</u>	<u>Qty</u>	<u>Price</u>
	100241 Allura Xper FD10	1	\$862,279.98
Equipment Total:			\$862,279.98

## Solution Summary Detail

<u>Product</u>	<u>Qty</u>	<u>Each</u>	<u>Monthly</u>	<u>Price</u>
100241 Allura Xper FD10	1	\$862,279.98		\$862,279.98

**Buying Group:** CAROLINAS HEALTHCARE SYSTEM SCA      **Contract #:** CAA0013200

**Add'l Terms:**

Each Quotation solution will reference a specific Buying Group/Contract Number representing an agreement containing discounts, fees and any specific terms and conditions which will apply to that single quoted solution. If no Buying Group/Contract Number is shown, Philips' Terms and Conditions of Sale will apply to the quoted solution.

Each equipment system listed on purchase order/orders represents a separate and distinct financial transaction. We understand and agree that each transaction is to be individually billed and paid.

**Payment Terms: 0% Down, 80% Upon Delivery, 20% Due When the Product is Available for First Patient Use, Net due 30 days from date of invoice**

---

## Quote Summary

100241 Allura Xper FD10

Qty	Product
1	NNAE357 Clarity FD10 Floor Catalyst
1	NNAE218 Cardiology Loyalty Package
1	NNAE853 FlexVision_XL 8 Input Package
1	NNAE463 Single Phase UPS
1	NCVA013 MRC-GS 05/08 X-Ray Tube
2	FCV0587 Xper Live/Ref Slaving
1	NCVB879 Aut Pos Contr Xper sys & table
1	NCVB209 Xper Swing
1	NCVA786 Vascular Quant.Sw pkg(Xper)
1	NCVA778 2nd Xper Module pr
1	NCVC199 Wireless footswitch: mono-plane version
1	NCVA097 Cath Arm Support
1	NCVA098 Pulse Cath Arm Support
1	NCVA783 Pivot for table base.
1	NCVA791 Xper Table Tilt
1	NCVC425 Table base Auxiliary OP rail
1	FCV0510 Long mattress cardio
2	FCV0017 CABLE CARRIER CS
1	NCVB947 XL screen video-share slaving
1	NCVB630 FlexVision XL,Snapshot
1	NCVB294 Set of 2 additional 21in. LCDs
1	NCVB591 2ND REF for FlexVision XL
1	989801256032 iXR Additional Training 16 Hours OnSite
1	980406041009 Rad Shield w/ Arm (Contoured) 61X76
1	980406190009 PIVOTING TABLE-MOUNTED RADIATION SHIELD
1	989801220012 Cable Spooler
1	989801220158 Mark 7 Arterion, Table Mount
1	989801220273 Ceiling Track w/Column & Handle Ext
1	989801220275 Q-Digital Charge Docking Station 6 Port
1	989801220276 Q-Digital AIO Headset
1	989801220279 LED Single Color Exam Lamp
1	989801220374 Q-Digital Base Station
1	989801220375 Black Anti-fatigue Floor Mat w/logo.

# Quote Summary

100241 Allura Xper FD10

Qty	Product
1	989801299617 XD8982ALLURAXPERCLARITYREL8.2CTC5D
1	989801299784 XD9702 Flexvision XL eLearn
1	989801299780 XD3894 ALLURA XPER REL8.2 ESSENTIAL
1	989600213942 AD5 TO XPER TABLE ADAPT. PLATE
1	SP003 Installation Labor
1	SP019 Trade in Allowance

## Options

Qty	Product
1	NCVA672 FD SmartMask
1	NCVB882 Cradle extension

## 100241 Allura Xper FD10

**System Type:** New  
**Freight Terms:** FOB Destination  
**Warranty Terms:** Part numbers beginning with two (2) asterisks (\*\*) are covered by a System 12 Months Warranty. All other part numbers are third (3rd) party items.  
**Special Notations:** Contingencies must be removed 120 days before scheduled shipment to assure delivery on specified date. Any rigging costs are the responsibility of the Purchaser.  
**Additional Terms:**

Line #	Part #	Description	Qty
--------	--------	-------------	-----

1	**NNAE357	Clarity FD10 Floor Catalyst	1
---	-----------	-----------------------------	---

The iXR Philips Catalyst Conversion Program is a practical and cost effective way to transform your current system into the AlluraClarity FD10 F

The AlluraClarity FD10 (Floor) single-plane cardiovascular system comprises a ceiling mounted G-arm stand and digital imaging X-ray system for cardiovascular diagnostic and interventional procedures.

ClarityIQ technology is the foundation of AlluraClarity systems touching every part of the imaging system.

ClarityIQ incorporates powerful state-of-the-art image processing technology, developed by Philips research, all working in real-time enabled by the latest computing technology:

- Noise and artifact reduction, also on moving structures and objects
- Image enhancement and edge sharpening;  
- Automatic real-time patient and accidental table motion correction on live images.
- Flexible digital imaging pipeline
- ClarityIQ systems have a flexible digital imaging pipeline from tube to display that is tailored for each and every application area such as Cardio or Neuro. This gives the flexibility to select virtually unlimited application-specific configurations.
- With ClarityIQ over 500 system parameters are fine-tuned for each application area; the result of years of Philips clinical leadership. It is now possible to filter out more X-ray radiation, use smaller focal spot sizes, shorter pulses, thereby fully utilizing the unique capabilities of the Philips MRC X-ray tube.

The AlluraClarity FD10 system uses an integrated single-host concept. The system is comprised of five functional building blocks: Geometry, X-ray Generation, Image Detection, Viewing, and User Interface. Each functional building block is explained in further detail including accessories.

### GEOMETRY

#### The AlluraClarity FD10 Stand

The floor mounted geometry segment. This component comprises the following features:

## 100241 Allura Xper FD10

Line #	Part #	Description	Qty
		<ul style="list-style-type: none"><li>• A motorized dedicated cardiovascular floor-mounted Poly-Diagnost G-stand with a rotatable base that allows for a clear area around the patient table. The stand is capable of manual or motorized movement.</li><li>• All stand movements are motorized. The manual and motorized parking movement consists of floor-mounted rotation. The counterbalanced Dynamic Flat Detector can be positioned manually and motorized. Angulation and Rotation of the Poly Diagnost G-arm is also motorized at high speeds.</li><li>• Parking and longitudinal movement of the Poly Diagnost G stand, can be performed either manually either motorized. The longitudinal movement comprises electronic auto-stop positions, to facilitate positioning in the iso-center with ease and accuracy.</li><li>• Single operator control of stand parking or longitudinal positioning. It provides motorized base rotation at 12 degrees/s from +90 to -90 degrees, and motorized longitudinal movement at 15 cm/s over a maximum range of 260 cm.</li><li>• The projection angles for the Poly Diagnost G-arm are:<ul style="list-style-type: none"><li>• Rotation 120 degrees LAO to 120 degrees RAO</li><li>• Angulation 45 degrees cranial to 45 degrees caudal</li></ul></li><li>• Motorized stand movements are variable speed with a configurable maximum speed, allowing:<ul style="list-style-type: none"><li>• Rotation speed up to 25 degrees/s</li><li>• Angulation speed up to 18 degrees/s</li></ul></li><li>• The depth of the Poly Diagnost G arm is 105 cm.</li><li>• The stand features BodyGuard capacitive sensing collision avoidance for patient protection.</li><li>• The variable source image distance range between the x-ray tube foci and the Dynamic Flat Detector input screen is 86.5 to 123 cm.</li></ul>	

### Patient Support

#### Xper Table

- Patient support provided with a flat carbon fiber tabletop
- Tabletop length of 319 cm and tabletop width of 50 cm
- Floating tabletop movement of 120 cm longitudinal and 35 cm transverse
- Motorized height adjustment from 74.5 to 102.5 cm
- Maximum cantilever of 223 cm , for full patient coverage
- Maximum patient weight 250 kg plus 500 N for CPR (or 225 kg plus 1000 N) in any longitudinal position of the table top
- Xper Geometry and Imaging Modules for exam room controls.
  - The operating modules can be attached to either side of the table.

### Patient Support Accessories

- Three rail accessory clamps
- Mattress pad
- Translucent catheterization armrest
- IV Pole
- Set of Cable Holders
- Set of Arm Supports (FCV0248)
- Arm Support (FCV0258)
- Patient straps



## 100241 Allura Xper FD10

Line #	Part #	Description	Qty
--------	--------	-------------	-----

- Table-mounted radiation shield
- Antifatigue Mat with Philips logo

### X-RAY GENERATION

The AlluraClarity FD10 comprises an integrated dedicated X-ray system, micro-processor controlled 100kW generator, based on high frequency converter technology. The user interface control of this X-ray Generator is incorporated into the Xper module, Xper Desktop Console, and the Xper on-screen displays.

The Certeray generator comprises:

- X-ray generator: 100 kW
- Voltage range: 40 - 125 kV
- Program selection:
  - Pulsed X-ray up to 3.75 , 7.5 , 15 , 30, frames/s for digital dynamic exposures
  - Pulsed X-ray for pulsed fluoroscopy (3.75, 7.5, 15, 25, 30 frames/s).
  - Minimum exposure time of 1ms.
  - ECG triggered acquisition: allows acquiring one exposure for each QRS peak with selectable delay time
  - Automatic kV and mA control for optimal image quality prior to run to save dose
  - Optimal X-ray tube load incorporated in the Certeray generator
- An X-ray collimator with single semi-transparent wedged filter with manual and automatic positioning.
- SpectraBeam filtering of low energy radiation to optimize image quality and dose efficiency with the MRC-GS 0508 X-ray tube.
- Xper Beam Shaping, which means that, both shutters and wedges can be positioned on the Last Image Hold without the need for X-ray radiation.

### Fluoroscopy

- Three programmable fluoroscopy modes can be selected from the Xper Imaging T.S.O. Each mode has a different composition of dose rate, pulse speed, filter setting, and image processing (noise reduction, adaptive contour enhancement, and adaptive harmonization).
- Xper Fluoro Storage, a grab function allows storage and archiving of a single fluoro frame or the last 20 seconds of fluoroscopy. These images or runs can be archived as a regular run.

### X-ray Tube

The AlluraClarity FD10 includes a Maximus ROTALIX Ceramic tube assembly MRC-GS 05 08 and cooling unit CU 3101 for cardio-vascular systems. Comprising:

- 0.5/0.8 mm nominal focal spot values maximal 45 and 85 kW

## 100241 Allura Xper FD10

Line #	Part #	Description	Qty
--------	--------	-------------	-----

### IMAGE DETECTION

The AlluraClarity FD10 comprises the following image detection chain:

- A 25 cm (10 in.) diagonal triple-mode Dynamic Flat Detector. It comprises a 6"/8"/10" triple mode Dynamic Flat Detector
- The outer detector box diameter is 37 cm diagonal square
- The digital output of the Flat detector is a 1024 x 1024 matrix at 14 bit depth and the detector pixel pitch is 184 micron by 184 micron
- The DQE (0) is 75% providing high conversion of X-ray into a digital image, while maintaining a high MTF.

### VIEWING

The AlluraClarity FD10 comprises the following components in order to display the clinical images in the control and examination rooms:

#### Displays

##### Examination Room

Two 19-inch monochrome LCD monitors

- 19-inch monochrome TFT-LCD display
- Native format 1280x1024 SXGA
- 10-bit gray-scale resolution with gray-scale correction

These monitors are not delivered when FlexVision XL, EP Cockpit or EP Cockpit XL is selected.

The monitor ceiling suspension in the exam room can be configured to accommodate 3, 4, 6, or 8 LCD monitors and includes motorized height adjustment. The height adjust feature is dependent on the room ceiling height. When FlexVision XL, EP Cockpit or EP Cockpit XL is selected the monitor ceiling suspension is configured for one of those options.

- The first reference channel is for the display of reference images or runs, controlled by infra-red remote-control Xper Viewpad.
- The On-Screen Display provides status information on stand rotation, angulation, display of system messages, X-ray tube load status, selected fluoroscopy mode, selected detector Field of View, and both the rate and accumulation of the dose area product and skin dose.

##### Control Room

One 19-inch color LCD monitor

- 19-inch color TFT-LCD display

Line #	Part #	Description	Qty
--------	--------	-------------	-----

### Control Room

One 19-inch monochrome LCD monitor

- 19-inch monochrome TFT-LCD display
- Native format 1280x1024 SXGA
- 10-bit gray-scale resolution with gray-scale correction

These control room monitors are not delivered when EP Cockpit or EP Cockpit XL is selected.

### Acquisition

The acquisition segment coordinates the parameters for automatic exposure control. The program is selected via the Xper module or Xper Desktop Console.

This AlluraClarity offers a storage capacity of:

- 100,000 images at matrix size of 1024 x 1024, 10-bit
- Maximum number of examinations is 999, with no limit to the maximum number of images per examination

### USER INTERFACE

Xper is comprised of three elements: 1) Xper Settings, which customizes the system to each user preferred settings; 2) Xper User Interface 3) Xper Integration, which makes advanced integration functionality available such as DICOM Query / Retrieve, background archiving, and Xper Fluoro Storage.

The Xper User Interface comprises a range of User Interface modules in the Examination Room, including On-Screen Display.

### On-Screen Display

- X-ray indicator and X-ray tube temperature condition
- Gantry position in rotation and angulation and Source Image Distance
- Detector field size display
- Selected Frame speed
- Fluoroscopy mode
- Integrated fluoroscopy time
- Stopwatch
- Skin Dose: dose rate with X-ray, cumulated dose with no X-ray
- Dose Area Product: dose rate with X-ray, cumulated dose with no X-ray
- Graphical bars for indication of Body Zone specific dose rate and accumulated skin dose levels, related to the 2 Gy level

Remote Intercom

Line #	Part #	Description	Qty
		A separate intercom, which is connected independently from the system that allows separate placement of the intercom at the preferred working position in the control room and examination room.	

### **Xper ViewPads**

The Xper ViewPad contains the preprogrammed function settings. The system is provided with two Xper ViewPads. The following functions are provided:

- Run and image selection
- File and run cycle
- File overview
- Store to Reference image file
- Copy image to photo file
- Digital (fixed) zoom and panning
- Recall reference images, which means switching control of Xper ViewPad function from live to reference monitor
- Laser pointer, intended to point at regions of interest on the imaging monitors
- LED indication of laser pointer on/off and battery low

### **Tableside Modules**

One Xper Module is provided for use at either the tableside or in the control room. This module uses a touch screen, which can be operated when draped with sterile covers. The Xper Module contains the following functionality:

- Acquisition settings
- Selection of Xper Setting allows the user to set frame rates and x-ray generation settings applicable for the type of the preferred intervention
- Automatic positioning recall to allow the stand position to match the reference image.
- Image Processing

The Xper Geometry T.S.O. module can be positioned on all sides of the patient table, while keeping the button operation intuitive. The Xper Geometry T.S.O. provides the following functionality:

- Tabletop float and table height position
- Source Image Distance selection
- longitudinal movement of the Gantry along the ceiling
- Gantry rotation in an axis perpendicular to the ceiling
- Store and recall of two scratch gantry positions including SID
- Emergency stop button

The Xper Imaging T.S.O. module can also be positioned at three sides of the patient table, while keeping the button operation intuitive. The Xper Imaging T.S.O. provides the following functionality:

- Fluoroscopy Flavor selection defined per Xper Setting
- Shutters and Wedge positioning

## 100241 Allura Xper FD10

Line #	Part #	Description	Qty
--------	--------	-------------	-----

- Xper Fluoro Storage and Grab
- Selection of the Detector field size
- Shutters positioning
- Reset of the fluoroscopy buzzer

### **Pan Handle (NCVA081)**

The Pan Handle is an extension of the control facility for floating movements of the table top.

### **Control Room**

The control room comprises an Xper Review Module, a keyboard, a mouse. The Xper Review Module offers the basic functions for review. The Xper Review Module contains the following functionality:

- Power on/off
- Tagarno wheel to control the review of a patient file
- File and run cycle
- Contrast, Brightness, and Edge enhancement settings
- File, Run, Image stepping and run and file overview
- Delete run
- Image invert and digital zoom
- Reset fluoroscopy timer and enable/disable X-ray

System information is displayed on the bottom of the data monitor:

- Stopwatch and Time
- System guidance information
- Dose Area Product (DAP), Skin Dose, and accumulative dose
- Frame speed settings, fluoroscopy mode, and accumulated fluoroscopy time
- Exposure and fluoroscopy settings as Voltage (kV), Current (mA) and pulse time (ms)
- Geometry information as rotation, angulation, and SID

The workflow is divided in scheduling, preparation, acquisition, review, and archive.

Any Allura system built after Jan 1, 2017, will use and include Windows 7 (embedded standard).

### **Scheduling**

The patients can be added, listed and selected per date, physician, and intervention type. Previous DICOM patient studies can be uploaded with the DICOM Query Retrieve function.

Patient management protocols are flexible and allow for multiple studies to be selected under one patient identification number. This means that new studies can be appended to an earlier patient file. Furthermore, each study can contain multiple examinations to allow for split administrative

Line #	Part #	Description	Qty
		purposes. Each examination contains multiple files, i.e. acquisition file, reference file, and QA results file.	

### Preparation

The preparation page provides the information of the room and patient preparation of each individual physician. The preparation page is customizable per Xper Setting and allows each physician to provide his or her own room protocols.

### Acquisition

The acquisition page contains information on the current selected patient.

### Review

The review page allows for reviewing of patient's:

- Previous examination cases
- Review of other DICOM XA or DICOM SC studies.

### Radiation Dose Structured Report

Collection of dose relevant parameters and settings and export to a DICOM database (e.g. PACS, RIS), according IEC60601-2-43, 2nd Edition.

The reported data can be used for, for example:

- Quality improvement: evaluating trends in X-ray dose performance per facility, system and operator.
- RDSR enables analysis of average dose levels & variance for routinely performed exams and procedures.
- Typical system usage can be extracted from the data.

### Secondary Capture Dose Report

- The Secondary Capture Dose Report function allows the user to save & transfer, manually or automatically, a patient Dose Report to PACS in DICOM secondary capture format.
- The dose report will be stored in the related patient image folder.

### Archive Continuous Autopush (NCVA090)

Continuous Autopush is an archive accelerator which ensures that background archiving continues with minimal disruptions.

Line #	Part #	Description	Qty
		Clinical studies can be archived to a CD or a PACS. The archive process can be completely automated and customized with Xper Settings. Parameters like multiple destinations and archive formats can be selected to the individual needs.	
		The Xper DICOM Image Interface enables the export of clinical images to PACS. The export formats are based on DICOM 3.0 protocols. The system exports clinical studies in Cardiac DICOM XA Multi-Frame or DICOM Secondary Capture formats. <ul style="list-style-type: none"> <li>The export format is configurable in 512x512 or 1024x1024.</li> <li>The examination can be sent to multiple destinations for archiving and reviewing purposes.</li> <li>The Xper DICOM Image Interface provides DICOM Storage and DICOM Storage Commitment Services.</li> <li>The DICOM Query/Retrieve function allows older DICOM XA MF and DICOM SC studies to be uploaded in the system. Furthermore, additional information can be appended to a study, while keeping the patient identification the same.</li> </ul>	

### Clinical Education Program for Allura Systems

**Essentials OffSite Education:** Philips will provide up to two (2) Cardiovascular Technologists, Registered Technologists Registered Nurses, or other system operator as selected by customer, with in-depth didactic, tutorial, and hands-on training covering basic functionality and work-flow of the cardiovascular imaging system. In order to provide trainees with the ability to apply all fundamental functioning on their system, and to achieve maximum effectiveness, this class should be attended no earlier than two weeks prior to system installation.

**In the event that an EP Navigator workstation has also been ordered, the offsite training course will be tailored to focus on the electrophysiology functionality of the FD system and the EPN workstation.**

**In the event that your main FD system will be dedicated to Cardiac applications your offsite training course will be tailored to focus on the Cardiac functionality.**

This twenty-eight (28) hour class is located in Cleveland, Ohio, and is scheduled based on your equipment configuration and availability. Due to program updates, the number of class hours is subject to change without notice. Customer will be notified of current, total class hours at the time of registration. This class is a prerequisite to your equipment handover OnSite Education. CEU credits may be available for each participant that meets the guidelines provided by Philips. Please refer to guidelines for more information. **Travel and lodging are not included, but may be purchased through Philips. It is highly recommended that 989801292102 (CV Full Travel Pkg OffSite) is purchased with all OffSite courses.**

**Handover OnSite Education:** Philips Education Specialists will provide twenty-eight (28) hours of education for up to four (4) students, selected by customer, including technologists from night/weekend shifts if necessary. Students should attend all 28 hours, and must include the two OffSite education attendees. CEU credits may be available for each participant that meets the guidelines provided by Philips. Please refer to guidelines for more information. Note: Site must be patient-ready. Philips personnel are not responsible for actual patient contact or operation of equipment during education sessions except to demonstrate proper equipment operation. **It is highly recommended for systems that are fully loaded or for customers with a large number of staff members to also purchase 989801292099 (CV Add OnSite Clin Educ 24h).**

Education expires one (1) year from equipment installation date (or purchase date if sold separately). Ref# 106107-110915

Line #	Part #	Description	Qty
2	**NNAE218	Cardiology Loyalty Package Digital subtracted Angio	1

The DSA-option allows to extend the application functions with additional vascular studies. DSA features real-time digital subtraction at low frame speeds of 0.5, 1, 2, 3, or 6 frames per second. The DSA programs can be selected per Xper Settings. It offers exposure technique for uncompromised image quality of subtracted images. In addition, this option also allows subtraction on run basis (run-subtract), which can be applied in the Rotational Scan and Bolus Chase Subtract options

This function will comprise following functionality:

- Fluoro-Trace
- Fluoro-Subtract
- Exposure subtract on individual image or run basis
- Mask selection
- Landmarking
- Pixel shift

Compatible with:

- . Allura Xper FD10 Rel 3 onwards
- . Allura Xper FD10/10 Rel 2 onwards

### RIS/CIS Dicom Interface

This package allows communication of the Allura Xper system with a local information system (CIS or RIS). The interface uses the DICOM Worklist Management (DICOM WLM) and Modality Performed Procedure Step (DICOM MPPS) standards.

If a hospital has an Allura Xper system and an information system it can receive patient and examination request information from the information system and report examination results in order to:

- Eliminate the need for retyping patient information on the Allura Xper
- Prevent errors in typing patient names and registration numbers (ensuring consistency with IS information to prevent problems in archive clusters ortosearch fora name in case of later retrieval)
- Inform the IS about the acquired images and radiation dose

Upon request from the Allura Xper system the complete worklist with all relevant patient and examination data is returned from the IS to the Allura Xper system. For each patient the following information will be shown on the Allura Xper after it has been retrieved from the IS:

Patient Identification:

- Patient name
- Patient ID
- Birth date
- Sex

Examination/Request Information:

- Accession number



Line #	Part #	Description	Qty
--------	--------	-------------	-----

- Scheduled procedure step start time
- Scheduled performing physician's name

It is possible at all times to enter patient demographics information manually within the Allura Xper system in case of an emergency or in case the local Information System connection is down.

On request of the clinical user the Allura Xper will report the following information about the selected patient to the IS:

Patient Identification:

- Patient name
- Patient ID
- Birth date
- Sex

Examination/Request Information:

- Accession number
- Performed procedure step status start/end date and time
- Performing physician's name
- Referenced image sequence

Radiation dose:

- Total time of fluoroscopy
- Accumulated fluoroscopy dose
- Accumulated exposure dose
- Total dose
- Total number of exposures
- Total number of frames

Further detailed information can be found in the Allura Xper DICOM Conformance Statement.

The interface requires an EasyLink (hardware and software) if the IS is not compliant with DICOM Work List Management and Modality Performed Procedure Step.

### Full AutoCal

The AutoCal option is a software package to be used in conjunction with quantitative analysis software packages. It provides an auto calibration procedure for an object to be analyzed that is placed in the iso-center. When the object to be analyzed (e.g. Left Ventricle Vessel Segment) is placed in the iso-center AutoCal avoids the need to:

- acquire an additional image series containing a sphere or grid for calibration purposes
- calibrate manually on a calibration object (e.g. catheter) displayed in the image or image series to be analyzed

### Ventricular Quant.Sw pkg(Xper)

Left Ventricular Quantification Software Package. Software package for the analysis of single plane Left ventricular angiograms. Calculates the Ejection fraction and local wall motion

## 100241 Allura Xper FD10

Line #	Part #	Description	Qty
--------	--------	-------------	-----

parameters in different formats.

Functions:

- Various LV-volumes
- Ejection Fraction
- Cardiac Output
- Centerline Wall Motion
- Slager Wall Motion
- Regional Wall Motion
- Calibration routines

In addition the package allows manual measurements of line lengths (absolute and ratio's) and angulations. Multiple measurements in one image are possible.

Comprising:

- software license

Compatible with:

- . Allura Xper FD 10 Rel 3 and FD10/10 Rel 2 onwards
- . Allura Xper FD20 Rel 2, FD20/10 Rel 2 onwards

### **Coronary Quant.Sw pkg(Xper)**

Functions:

- diameter measurement along the selected segment
- cross sectional area
- %-stenosis
- pressure gradient values
- stenotic flow reserve
- calibration routines

In addition the package allows manual measurements of line lengths (absolute and ratio's) and angulations. Multiple measurements in one image are possible.

Comprising:

- software license

Compatible with:

- . Allura Xper FD 10 Rel 3 and FD10/10 Rel 2 onwards
- . Allura Xper FD20 Rel 2, FD20/10 Rel 2 onwards

### **Rotational Scan**

Rotational Scan provides real-time 3D impressions of complex vasculature and the coronary artery tree. It acquires multiple projections with just one contrast injection.

## 100241 Allura Xper FD10

Line #	Part #	Description	Qty
--------	--------	-------------	-----

Rotational Scan can be used during screening procedures to quickly determine the optimal projection for the study as the angle (rotation/angulation) of the projection is indicated on each image.

Compared with traditional angiography Rotational Scan can save considerable time dose and contrast while providing image detail required for diagnostic and therapeutic decisions.

Rotational Scan is possible with the Allura Xper systems in the side position (ceiling mounted systems) and in the head position which provides the flexibility to perform procedures virtually from head to toe.

### With Allura Xper FD20

C-arm in side position:

- Max. rotation speed: 30°
- Max. rotation angle: 180°

C-arm in head position:

- Max. rotation Speed: 55°
- Max. rotation Angle: 305°

### With Allura Xper FD10:

Poly G in side position (ceiling version):

- Max. rotation Speed: 30°
- Max. rotation Angle: 90°

Poly G in head position:

- Max. rotation Speed: 55°
- Max. rotation Angle: 240°

Maximum speeds are given by the framespeed specifications of the system configuration.

The speed and range of rotation are the highest available (see table). The very high speed allows using less contrast whereas the very wide rotation range provides a complete evaluation of the anatomy.

The stand is designed for very high mechanical stability. It offers precise positioning and high reproducibility assuring you of high quality images and excellent studies.

Operation of Rotational Scan is extremely easy. The procedure is selected set up and executed virtually within a matter of seconds supporting the highest patient throughput. A set of dedicated acquisition programs is available on the Xper Module and can be selected at the touch of a button.

**100241 Allura Xper FD10**

Line #	Part #	Description	Qty
--------	--------	-------------	-----

The rotation end and start positions are easily selected. The procedure is controlled from the exposure hand

- or foot-switch.

<b>3</b>	<b>**NNAE853</b>	<b>FlexVision_XL 8 Input Package</b>	<b>1</b>
----------	------------------	--------------------------------------	----------

The FlexVision XL8 input package provides eight isolated wall connection boxes.  
Isolated Wall Connection Box

This Isolated Wall connection Box facilitates connection of the video source via standard DVI cable/connector and lossless transfer of the video signal over the approximate 30 m cable distance. It can be mounted in the exam room or in the control room, depending on the location of the video source.

The quantity of the VWCB's has to be calculated as follows:

For each video signal to FlexVision XL on Vascular System: 8 VWCB

Note:

No VWCB is required in case a video signal is connected directly to a dedicated LCD from the following sources:

- 1) Xper Live/ref Slaving
- 2) Interventional HW (XtraVision), ViewForum, Xcelera (only if workstations are powered by Allura Xper)
- 3) Xper IM

<b>4</b>	<b>**NNAE463</b>	<b>Single Phase UPS</b>	<b>1</b>
----------	------------------	-------------------------	----------

The single phase UPS (Uninterruptable Power System) enables a proper shut-down of the Allura system processor-units in case of a hospital mains power failure.

Note:

In case a (local) three phase UPS is used, the single phase UPS is not required.

<b>5</b>	<b>**NCVA013</b>	<b>MRC-GS 05/08 X-Ray Tube</b>	<b>1</b>
----------	------------------	--------------------------------	----------

Featuring:

- SpectraBeam pre-filter
- SyncraPulse Pulsed Progressive Fluoroscopy
- 2.4 MHU anode heat storage capacity
- 900 kHU/min heat dissipation

Comprising:

**100241 Allura Xper FD10**

<b>Line #</b>	<b>Part #</b>	<b>Description</b>	<b>Qty</b>
		<ul style="list-style-type: none"> <li>• Maximus ROTALIX Ceramic tube (MRC-GS 05/08 with Grid Switch for pulsed fluoroscopy)</li> <li>• Tube Housing (ROT1001)</li> <li>• Cooling Unit (CU3000)</li> <li>• MRC Rotor Control</li> <li>• High Voltage Cables</li> </ul>	
<b>6</b>	<b>**FCV0587</b>	<b>Xper Live/Ref Slaving</b>	<b>2</b>
		This option contains a kit to split the Live or Ref video source from the Allura Xper. The total amount of Xper Live/Ref Slaving that can be selected is maximal. 4. Additional monitors are not included in this option and must be ordered separately. This kit contains a video splitter and a cable set for one slave monitor. The Slave monitor is not powered by Allura.	
<b>7</b>	<b>**NCVB879</b>	<b>Aut Pos Contr Xper sys &amp; table</b>	<b>1</b>
		<p>This Automatic Position Controller (APC) combines APC for Allura Xper FD10 and FD20 systems with table APC.</p> <p>System APC provides two modes of operation:</p> <p>Preset Position Sequence: the sequence of projections is determined through personalized Xper Settings. Each set contains a maximum of 10 positions. Positions can be recalled in sequence or directly. The projection sequence comprises rotation angulation and SID settings related to the selected reference image.</p> <p>Reference driven positioning: The projections on the reference monitors can be recalled with the push of a button. The reference driven positioning recollects the C-arm rotation angulation Flat detector image format and SID.</p> <p>Table APC</p> <p>The Automatic Position Controller (APC) for the table provides two modes of operation:</p> <p>Auto positioning. The tabletop position and table height will be adjusted automatically to the pre-defined default point of interest. This to save time and x-ray dose at the start of an exam or for setting up the system for rotation scans.</p> <p>Store/recall of a position of the table top. This includes the height-, longitudinal- and lateral position of the table top.</p>	
<b>8</b>	<b>**NCVB209</b>	<b>Xper Swing</b>	<b>1</b>
		<p>XperSwing allows dual-axis rotational coronary angiography to gather more information in less time and with less X-ray and contrast dose. XperSwing acquires simultaneous RAO/LAO cranial-caudal views in just one acquisition run by moving the C-arm in a curved trajectory instead of multiple acquisitions. XperSwing can be used during screening procedures to quickly determine the optimal projection for the study as the angle (rotation/angulation) of the projection is indicated on each image, providing image detail required for diagnostic and therapeutic decisions and to obtain a real-time 3D impression of the coronary artery tree.</p> <p>In total seven pre-programmed trajectories are available:</p> <ul style="list-style-type: none"> <li>• Three for Left coronary imaging</li> <li>• Two for Right Coronary imaging,</li> <li>• Two generic trajectories.</li> </ul> <p>The choice depends on size and weight of the patient. These trajectories are designed to fully cover all conventional projections for a diagnostic coronary angiography. Rotation and angulation movements are combined in one complete scan trajectory, using the maximum rotation and angulation speed of the Allura system. (55 resp 30 degr/sec). XperSwing is possible in the side position (ceiling mounted systems) and in the head position</p>	

## 100241 Allura Xper FD10

Line #	Part #	Description	Qty
--------	--------	-------------	-----

XperSwing functionality includes, but is not limited to

- 15 frames per seconds acquisition to allows using of less contrast.
- Wide rotation range provides a complete evaluation of the anatomy.
- Precise positioning and high reproducibility, assuring you of high quality images and excellent subtraction studies.
- Set up and executed in a matter of seconds.
- Set of dedicated acquisition programs with the trajectories available on the Xper Module
- The rotation end- and start-positions can be selected.
- Acquisition procedure is controlled from the exposure hand or footswitch.

9	**NCVA786	Vascular Quant.Sw pkg(Xper)	1
---	-----------	-----------------------------	---

Functions:

- vessel diameter / stenotic index
- automated vessel analysis
- calibration routines

In addition the package allows manual measurements of line lengths (absolute and ratio's) and angulations. Multiple measurements in one image are possible.

Compatible with:

- Allura Xper FD10 Rel 3 and FD10/10 Rel 2 onwards
- Allura Xper FD20 Rel 2 and FD20/10 Rel 2 onwards
- Allura CV20 R1 onwards

10	**NCVA778	2nd Xper Module pr	1
----	-----------	--------------------	---

The second Xper Module is equal to the standard Xper Module and provides touch screen control of displayed functionality.

The following functions can be made available providing the relevant commercial options have been selected:

- Acquisition settings
- Image processing controls
- Automatic position control (optional)
- Channel selection for MultiVision
- Quantitative Analysis controls (optional)
- Xcelera and ViewForum viewing (optional)
- Interventional tool controls (optional)
- Allura 3D-RA, Dynamic 3D Roadmap
- StentBoost, Allura 3D-CA
- XperCT, XperGuide
- XIM physiomonitring controls (optional)

Comprising:

- Xper Module with Cabling
- Mounting materials
- Software

**100241 Allura Xper FD10**

Line #	Part #	Description	Qty
--------	--------	-------------	-----

Connectivity:

A maximum of 3 Xper modules can be connected to the Allura Xper system:

- one Xper module can on the XperTable
- one Xper module in the control room
- one Xper module on the Xper Pedestal

Compatible with:

Allura Xper FD20 Rel.3

Allura Xper FD20/10 Rel.2

Allura Xper FD20/20 Rel.1

Power requirements: refer to system configuration.

11	**NCVC199	<b>Wireless footswitch: mono-plane version</b>	1
----	-----------	--	---

One wireless footswitch in the examination room.

**Key benefits**

- Reduces clutter around the examination table
- Simplifies preparation and cleanup
- Streamlines workflow in the interventional suite

**Reduce clutter and streamline workflow**

The wireless footswitch option streamlines workflow, reduces clutter, and simplifies preparation and cleanup in the interventional suite. Clinicians can use the footswitch to wirelessly control the X-ray system in the examination room, from any convenient position around the table. No sterile covers are needed with the IPX8 certified waterproof design.

**Specifications**

- The mono-plane wireless footswitch is a 3 pedal version; one pedal for fluoroscopy, one for exposure and one to control the room light/single shot. The pedals can be configured according customers preferred lay-out.
- The wireless footswitch is working via RF technology and is fully tested and released for medical use. It has an active range up to 10 meters, depending on structures within this range.
- The wireless footswitch has a lithium battery which only needs to be recharged once per week. During recharging the footswitch still can be used and is fully functional. In parallel, a wired footswitch can also be used.
- The status of the battery is indicated by an LED-indication on the footswitch itself, so that the user can decide when the footswitch needs to be recharged.
- The wireless footswitch has high water ingress protection standard (IPX8), it can easily be cleaned in water.

The wireless footswitch has an on/off switch. It can be switched off when not in use. When the footswitch is active, but not in use, it will go into a sleep-mode. It will be re-activated when touched or when one of the pedals is pressed.

12	**NCVA097	<b>Cath Arm Support</b>	1
----	-----------	-------------------------	---

For brachial catheterisation and digital imaging technique  
The support is made of X-ray transparent material with exception of the fixingclamp and pivots.

13	**NCVA098	<b>Pulse Cath Arm Support</b>	1
----	-----------	-------------------------------	---

**100241 Allura Xper FD10**

Line #	Part #	Description	Qty
		Facilitates catheterization through the pulse and provides room for placing catheterization instruments. It is a flat radio translucent board and is placed under the patient while a part projects at either the left or right side of the tabletop to support the arm.	
		Size: 100 x 85 cm Material: carbon-fibre reinforced material	

<b>14</b>	<b>**NCVA783</b>	<b>Pivot for table base.</b>	<b>1</b>
		For angiographic- and interventional procedures of the upper peripherals. Provides improved table access for patient transfer. Allows pivoting of the table base around its vertical axes. Pivot range from -90 degrees to + 180 degrees (or -180 to +90 degrees) with locked positions on 0, -13/+13 (facilitating arm-angiography) and -90/+90 and 180 degrees.	

Comprising:

- pivot device with graduated scale to be mounted on the universal floor plate of the table.

Compatible with Xper Table

<b>15</b>	<b>**NCVA791</b>	<b>Xper Table Tilt</b>	<b>1</b>
		This innovating SyncraTilt enhances the accuracy and efficiency of gravity-oriented procedures. It is available as an option for the Xper table in Allura Xper series systems.	

SyncraTilt is ideal for interventional, myelography, phlebography and head down procedures because it provides more precise imaging of contrast medium, blood, or objects in the body.

With SyncraTilt, the isocentre is automatically located at the isocentre of rotation and angulation of the stand. If the longitudinal position of the stand changes, the tilt isocentre is changed to match with the new stand position. As a result, the region of interest is always centred

As the table tilts, the X-ray beam automatically coordinates to the movement.

The table floats even when tilted, and the region of interest can be followed by panning the tabletop.

When combined with the Bolus Chase option, SyncraTilt enables phlebography to be performed with a head-up tilted patient.

The option provides:

- maximum tilt range:
- 17 degrees (head down) to +17 degrees (head up).
- tilt speed: 2 degrees/sec
- automatic safeguarding system with manual override
- panning range in tilted plane: equal to the standard
- tabletop specifications (longitudinal 120cm, lateral 35cm)
- easy to use controls

Comprising:

- Tilt drive with user controls



**100241 Allura Xper FD10**

Line #	Part #	Description	Qty
		Compatible with: . Xper table in Allura Xper FD series Rel 3 onwards (monoplane versions) and Rel 2 onwards (biplane versions) . Bolus Chase . Pivot for table base . swivel for table base	
16	**NCVC425	<b>Table base Auxiliary OP rail</b>	1
		<ul style="list-style-type: none"> <li>• Position operating modules and/or accessories conveniently</li> <li>• Work comfortably at the head end of the table</li> </ul> <p><b>Work comfortably at the head end of the table</b>                      To provide more flexibility when working at the head end of the table, the auxiliary OP (operation profile) rail can be used to position operating modules and/or accessories closer to the head end of the tabletop. This allows the user to work comfortably when performing pacemaker implantations, venous jugular catheter insertions, and other procedures near the patient's head.</p>	
17	**FCV0510	<b>Long mattress cardio</b>	1
		<ul style="list-style-type: none"> <li>• Enhances patient comfort</li> <li>• Adapts to the shape of the patient's body</li> </ul> <p><b>Enhance patient comfort during cardio exams</b>                      To enhance patient comfort during cardio exams, the inflatable, latex free mattress can be used. It is extra-long to accommodate the patient on the tabletop, and adapts to the shape of the patient's body. The pressure within the mattress is evenly distributed so that it recovers its original shape quickly.</p> <p>Dimensions of the mattress:                      Length: 3165mm                      Width: 500mm                      Height: 70mm                      Radius: 150mm</p>	
18	**FCV0017	<b>CABLE CARRIER CS</b>	2
		Additional carrier for suspension of cable hose from X-ray tube assembly or TV monitor.	
19	**NCVB947	<b>XL screen video-share slaving</b>	1
		The XL screen video-share interface enables to share all information being presented on the large 56-inch screen in the Examination Room.  The XL screen video-share interface provides two, simultaneously available, video outputs: <ul style="list-style-type: none"> <li>• A full resolution video-output (Quad HD = 3840*2160 ; 8 MegaPixel)</li> <li>• A downscaled resolution video-output (HD = 1920*1080 ; 2 MegaPixel).</li> </ul> The full resolution 8MP video-output is compatible with the following Dual DVI 3rd party monitors: <ul style="list-style-type: none"> <li>• Barco 56-inch: CML5682W4</li> <li>• Eizo 56-inch: Radiforce LS560W</li> <li>• Eizo 60-inch: Radiforce LX600W</li> </ul>	

**100241 Allura Xper FD10**

Line #	Part #	Description	Qty
--------	--------	-------------	-----

The downscaled 2MP resolution video-output can be used to connect to a (3rd party) HD display or to a 3rd party recording/streaming/reviewing solution.

Note: The information provided at the 3rd party monitors (2 & 8MP) video output cannot be used for diagnostic purposes.

<b>20</b>	<b>**NCVB630</b>	<b>FlexVision XL,Snapshot</b>	<b>1</b>
-----------	------------------	-------------------------------	----------

FlexVision XL is an integrated viewing solution designed to give you full control over your viewing environment.

The FlexVision XL provides the ability to:

- Display information from up to 8 sources simultaneously (incl. third party systems) on the Philips 58-inch color LCD with LED backlight in the Exam Room.
- Resize and/or enlarge information at any stage during the case.
- Select and customize viewing lay-outs of the Philips 58-inch color LCD via the Xper table-side module
- Overview connected equipment (incl. third party systems) from a single location.

The FlexVision XL consists of:

- DVI video composition unit.
  - o The DVI video composition unit allows the user to direct and switch the video output of all connected medical equipment to specific sub windows of the Philips 58-inch color LCD with LED backlight in the Exam Room.
  - o The DVI video composition unit is operated from the Xper tableside module.
  - o The DVI video composition unit supports a wide variety of display formats (up to 1920x1200)
  - o Up to 9 external inputs are connected to the DVI video composition unit via Wall Connection Box(es).
- Medical grade, high resolution color LCD in the Exam Room
  - o This display supports the image quality requirements for monochrome X-ray images as well as color images and replaces all displays normally delivered with an Allura Xper FD or AlluraClarity system for the Exam Room.
  - o Main characteristics are:
    - 58-inch, 8 Megapixel color LCD
    - Native resolution: 3840x2160
    - Brightness: Max: 700 Cd/m2 (typical) stabilized: 400 Cd/m2
    - Contrast ratio: 4000:1 (typical)
    - Wide viewing angle (approx. 176 degrees)
    - Constant brightness stabilization control
    - Lookup tables for gray-scale, color and DICOM transfer function
    - Full protective screen Ingress Protection: IP-21
  - Large color LCD control (Xper Module)
    - o Resize and/or enlarge information at any stage during the case via the Xper tableside module in the Exam or Control Room
    - o Select viewing lay-outs via the Xper table-side module in the Exam Room
    - o Create new layouts by matching inputs to desired locations on preset templates.
- Monitor Ceiling Suspension
  - o Monitor ceiling suspension for use in the Exam Room carries the 58-inch color LCD, providing highly flexible viewing capabilities. The monitor ceiling suspension is height-adjustable and moveable along ceiling rails. It can be positioned on either

**100241 Allura Xper FD10**

<b>Line #</b>	<b>Part #</b>	<b>Description</b>	<b>Qty</b>
		side of the table.	
		<ul style="list-style-type: none"> <li>• Snapshot               <ul style="list-style-type: none"> <li>o The snapshot function allows the user to store/save a screen-capture of any image on the 58-inch display as a DICOM Secondary Capture image to a connected PACS. The snapshot-all function allows the user to store/save a screen-capture for each displayed image in the Exam Room / Control Room as separate DICOM Secondary Capture images .</li> </ul> </li> </ul>	
<b>21</b>	<b>**NCVB294</b>	<b>Set of 2 additional 21in. LCDs</b>	<b>1</b>
		Two 21inch additional displays are located on top of the monitor ceiling suspension frame which carry the 56 inch large screen color LCD display.	
		These 2 additional LCD's can be used to display additional video sources or used as display back up for Hemo and Xray Live images. These LCD's have a fixed content.	
		Main characteristics of back-up displays are:	
		<ul style="list-style-type: none"> <li>• 21.3 inch, 2 Megapixel color LCD display</li> <li>• Max. resolution: 1600x1200</li> <li>• Brightness: 450 Cd/m2</li> <li>• Contrast ratio : 550:1</li> <li>• Wide viewing angle (approx. 170 degrees)</li> <li>• Constant brightness stabilization control</li> <li>• Independently selectable brightness settings for monochrome and color images</li> <li>• Independently selectable lookup table for gray-scale, color and DICOM transfer function</li> </ul>	
		FCV0587, "XPer Live/Ref Slaving" required when displaying X-Ray Live as back-up.	
<b>22</b>	<b>**NCVB591</b>	<b>2ND REF for FlexVision XL</b>	<b>1</b>
		2nd REF for FlexVision XL is optional on FlexVision XL. Second Ref images will be displayed on the large screen monitor.	
<b>23</b>	<b>**989801256032</b>	<b>iXR Additional Training 16 Hours OnSite</b>	<b>1</b>
		Clinical Education Specialists will provide sixteen (16) hours of IXR OnSite Education for up to four (4) students, selected by customer, including technologists from night/weekend shifts if necessary. CEU credits may be available for each participant that meets the guidelines provided by Philips.	
		Note: Philips personnel are not responsible for actual patient contact or operation of equipment during education sessions except to demonstrate proper equipment operation.	
		Education expires one (1) year from equipment installation date (or purchase date if sold separately).	
<b>24</b>	<b>**980406041009</b>	<b>Rad Shield w/ Arm (Contoured) 61X76</b>	<b>1</b>
		Contoured Rad Shield with Arm rest. 61X76	
<b>25</b>	<b>**980406190009</b>	<b>PIVOTING TABLE-MOUNTED RADIATION SHIELD</b>	<b>1</b>

**100241 Allura Xper FD10**

Line #	Part #	Description	Qty
--------	--------	-------------	-----

Table-mounted radiation shield for additional protection of physician and staff against scatter radiation. The shield consists of two protective parts: a lower shield and an upper shield. The shield is specially designed for use with the AD5 patient table.

The table mounted radiation shield provides the following features:

- Mounting to either the right or left table accessory rails;
- Pivoting into the required working position;
- Pivoting into the parking underneath the tabletop facilitating patient preparation;
- The upper shield can be positioned upright providing optimal protection or can be folded down for free access to the patient.

The table mounted radiation shield includes:

- Lower shield measuring 70 cm high 80 cm wide 0.5 mm Pbequivalence;
- Upper shield measuring 40 cm high 50 cm wide 0.5 mm Pbequivalence;
- Mounting clamp;

Docking device for wall mounting.

26	**989801220012	<b>Cable Spooler</b>	1
----	----------------	----------------------	---

27	**989801220158	<b>Mark 7 Arterion, Table Mount</b>	1
----	----------------	-------------------------------------	---

The Mark 7 Arterion Injection System is the latest in MEDRAD's "Mark" series of angiographic injectors. Compared to earlier systems, the Mark 7 Arterion injector head is lighter and easier to use so you can focus more on the patient.

The clear and intuitive user interface guides you through proper set-up, and highlights the information you need to perform safe procedures.

Unique to the market, the front load system simplifies set-up and makes for a cleaner tear down.

The clear syringe provides a higher level of confidence that you are ready to inject.

Made from a clear material, the Mark 7 Arterion syringe (Catalog ART 700 SYR) allows you to easily view the inside of the syringe for smoother purging of air. And MEDRAD's famous fluid dots are still there to help-round for fluid, oval for air.

The table mount injector solution ensures the contrast injector is conveniently placed and always available when it is needed. It provides a clean workspace without occupying valuable floor space.

System includes:

- Table Mount
- display control panel
- 6 ft. coiled hand switch
- operation manual (CD)
- 10 ft. head cable
- syringe heat maintainer
- imaging system interface cable for the Allura / Allura Xper
- consumables starters kit

For the MEDRAD Mark7 Injector system Philips is only the distributor. MEDRAD provides the service as well as the application support of both versions unless stated differently in the Philips Service Agreement

**100241 Allura Xper FD10**

Line #	Part #	Description	Qty
--------	--------	-------------	-----

System Specifications:

- Flow Rate 0.1-45.0 ml/s in 0.1 ml increments
- 0.1-59.9 ml/m in 0.1 ml increments
- Volume 1-150 ml in 1 ml increments
- Pressure Limit 100-1200 psi in 1 psi increments
- (150ml syringe) 689-8273 kPa in 1 kPa increments
- Rise Time 0.0-9.9 seconds in 0.1 increments
- Delay Time 0.0-99.9 seconds in 0.1 increments
- Fill Speed 1-20 ml/s
- Fill Volume 1-150 ml
- Syringe Size 150 ml
- Syringe Heat Maintainer 35 °C (95 °F) ± 5 °C (9 °F)
- Protocol Memory 40 Protocols
- Injection Memory History

28	**989801220273	<b>Ceiling Track w/Column &amp; Handle Ext</b>	1
Mavig 2.5m Ceiling Track with Ceiling trolley, 360 degree column, and brake handle extension.			

29	**989801220275	<b>Q-Digital Charge Docking Station 6 Port</b>	1
CHARGER Q-RCH Capacity: 6 port Power requirements: 12v c/w external power supply Dimensions H x W x D: 110mm x 330mm x 100mm Weight: 1kg Mounting: Wall/desk Charge modes: Fast charge			

30	**989801220276	<b>Q-Digital AIO Headset</b>	1
HEADSET Q-RH7/N Frequency: 1.910-1.930 GHz Weight: 50g Battery: Removable Lithium Ion Charge time: 2.5 hours Battery capacity between charges: 8 hours push-to-talk, 6 hours talk-lock Operating modes: Vox, talk-lock and push-to-talk standard Voice prompts (range + charging): Registration status, battery low and out-of-range voice prompts standard Volume control: 5-stage, slide button up/down Microphone: Noise canceling			

31	**989801220279	<b>LED Single Color Exam Lamp</b>	1
LED Single Color M LED130F Examination Lamp			
Portegra2 Extension/Spring Arm Combination with M LED 130F, Single Color, incl. Power Supply			
Light in new dimension LED lamps support your daily operations through innovative technology and design. In addition to advantages provided by MAVIG with all light equipment, LED technology offers the following enhanced features:			

**100241 Allura Xper FD10**

Line #	Part #	Description	Qty
		<ul style="list-style-type: none"> <li>• Faceted multi-lens system</li> <li>• In-depth illumination</li> <li>• Superior color rendition</li> <li>• Extension arm 750mm</li> <li>• Spring arm 900mm</li> <li>• LED-Examination-light</li> <li>• Operating voltage is 24V DC. The lamp is supplied with a transformer, should it be used with 230V.</li> </ul>	

Technical data LED 130F:

- Light intensity at 1 meter distance: 60.000 Lux
- Color rendering index: Ra = 95
- Focusable: yes
- Focusable size of the light field: 14-25 cm
- Color temperature: 4500 Kelvin
- Electronic light intensity control at the lamp head: standard dimming range: 50 - 100 %
- Temperature increase in head area: 0.5° C
- Mains: 230 V / 60 Hz
- Power consumption: 28 W
- Number of LEDs: 19
- Life-span of the LEDs: > 40.000 h
- Diameter of the lamp head: 33 cm
- Working distance: 70 - 140 cm
- Height Adjustment: 117 cm

<b>32</b>	<b>**989801220374</b>	<b>Q-Digital Base Station</b>	<b>1</b>
-----------	-----------------------	-------------------------------	----------

The Q-Digital Base Station includes the following items:

One BASE STATION : QDHCBS  
 Operating frequency: 1.910-1.930 GHz North America  
 Power requirements: 100-240v AC voltage sensing (mains cable supplied)  
 Dimensions H x W x D: 168mm x 128mm x 36mm  
 Weight: 400g  
 Headset capacity: Up to 30 headsets per base station.

<b>33</b>	<b>**989801220375</b>	<b>Black Anti-fatigue Floor Mat w/logo.</b>	<b>1</b>
-----------	-----------------------	---	----------

Black Anti-fatigue Floor Mat with Philips Logo

36" x 60"

<b>34</b>	<b>**989801299617</b>	<b>XD8982ALLURAXPERCLARITY REL8.2CTC5D</b>	<b>1</b>
-----------	-----------------------	--	----------

Allura Xper / Clarity release 8.2

Course Number: XD8982  
 System Codes: 722-026, 722-027, 722-028, 722-029, 722-033, 722-034, 722-035, 722-036, 722-038, 722-039  
 Course Title: Allura Xper / Clarity release 8.2  
 Course Length: 5 days

## 100241 Allura Xper FD10

Line #	Part #	Description	Qty
--------	--------	-------------	-----

Delivery Method(s): ILT  
Modality: iXR-CV  
Location: PHC and CTC  
Target Audience: CS Field Service Engineers

### DESCRIPTION:

This course will provide information on and in insights in the differences between Allura Xper release 8.1 and Allura Xper / Clarity release 8.2.

### PREREQUISITES:

XD3970, Allura Xper Rel 7.6 part 1(Or history courses XD3966 & XD9065 or XD3875 & XD9065);

Field experience;

XD9906, Allura Xper update to R8.1;

FC9021 Cat Tool.

### COURSE OBJECTIVES:

Upon completion of this course and using the appropriate service manuals, the FSE can:

- Identify differences between the 8.1 release and the 8.2 release.
- Recognize new system parts.

- Certeray Generator

- motion control Clea-stand

- FD20 and FD15 detector

- AD7XT and AD7XNT table

- Power Supply gPDU

- Cabinet layout and cable routing

- Identify and sequence the steps to installing an 8.2 release.
- Identify the new service documentation structure
- Identify the Diagnostic CM procedures.

\* PHILIPS PROPRIETARY MATERIALS SUCH AS DIAGNOSTIC SOFTWARE AND SERVICE DOCUMENTATION ARE NOT INCLUDED IN THE TRAINING AND WILL NOT BE AVAILABLE FOR USE OUTSIDE OF THE TRAINING ENVIRONMENT. THE TRAINEE MUST RETURN ALL PROPRIETARY MATERIALS RECEIVED DURING THE TRAINING AT THE END OF THE TRAINING. CUSTOMER ACKNOWLEDGES AND AGREES THAT NEITHER CUSTOMER NOR TRAINEE WILL RECEIVE A LICENSE TO SUCH PROPRIETARY MATERIALS AND THAT THE TRAINEE MAY NOT BE ABLE TO FULLY UTILIZE THE TRAINING WITHOUT THE USE OF SUCH PROPRIETARY MATERIALS. (CERTAIN LICENSES MAY BE OBTAINED THROUGH PURCHASE OF SUPPORT OR ASSIST AGREEMENT.) Course dates and location to be finalized by Philips. Philips shall attempt to accommodate Customer requested dates and training location.

**100241 Allura Xper FD10**

Line #	Part #	Description	Qty
--------	--------	-------------	-----

The price quoted includes course tuition. Travel and living expenses are not included, but may be purchased separately through Philips.

**IMPORTANT Notes Regarding Admission to Philips Customer Engineer Training Courses:**

1. Trainee must meet all prerequisites
2. Course expires one (1) year from equipment installation date (or purchase date if sold separately)
3. Customer must sign Philips Nondisclosure statement
4. Trainee must sign Philips Nondisclosure statement
5. Customer must sign Philips terms and conditions of training

<b>35</b>	<b>**989801299784</b>	<b>XD9702 Flexvision XL eLearn</b>	<b>1</b>
-----------	-----------------------	------------------------------------	----------

Course Number: XD9702  
 Course Title: FlexVision XL  
 CSIP Level: All course materials are on CSIP level 1  
 Course Length: 10 hours  
 Delivery Method(s): Standard eLearning  
 Modality: IGT Systems  
 Location: Online  
 Target Audience: Field Service Engineers and Licensed Representatives  
 System Code(s): Not applicable

**DESCRIPTION:**

This e-learning module will familiarize the engineer with FlexVision XL basics with regards to:

- System Architecture
- Signal Flow
- Setting to Work
- Monitor replacement

This course has a one question exam only. You have to declare that you studied and understood the content in order to be certified as trained.

**PREREQUISITES:**

All of the below courses:

- FC9002 – Safety
- FC9003 – Imaging Systems Safety

\* PHILIPS PROPRIETARY MATERIALS SUCH AS DIAGNOSTIC SOFTWARE AND SERVICE DOCUMENTATION ARE NOT INCLUDED IN THE TRAINING AND WILL NOT BE AVAILABLE FOR USE OUTSIDE OF THE TRAINING ENVIRONMENT. THE TRAINEE MUST RETURN ALL PROPRIETARY MATERIALS RECEIVED DURING THE TRAINING AT THE END OF THE TRAINING. CUSTOMER ACKNOWLEDGES AND AGREES THAT NEITHER CUSTOMER NOR TRAINEE WILL RECEIVE A LICENSE TO SUCH PROPRIETARY MATERIALS AND THAT THE TRAINEE MAY NOT BE ABLE TO FULLY UTILIZE THE TRAINING WITHOUT THE USE OF SUCH PROPRIETARY MATERIALS. (CERTAIN LICENSES MAY BE OBTAINED THROUGH PURCHASE OF A PHILIPS RIGHTFIT SERVICE AGREEMENT.) Course dates and location to be finalized by Philips. Philips shall attempt to accommodate Customer requested dates and training location. The price quoted



**100241 Allura Xper FD10**

Line #	Part #	Description	Qty
--------	--------	-------------	-----

includes course tuition. Travel and living expenses are not included, but may be purchased separately through Philips.

IMPORTANT Notes Regarding Admission to Philips Customer Engineer Training Courses:

- Trainee must meet all prerequisites
- Course expires one (1) year from equipment installation date (or purchase date if sold separately)
- Customer must sign Philips Nondisclosure statement
- Trainee must sign Philips Nondisclosure statement
- Customer must sign Philips terms and conditions of training

<b>36</b>	<b>**989801299780</b>	<b>XD3894 ALLURA XPER REL8.2 ESSENTIAL</b>	<b>1</b>
-----------	-----------------------	--	----------

PHILIPS PROPRIETARY MATERIALS SUCH AS DIAGNOSTIC SOFTWARE AND SERVICE DOCUMENTATION ARE NOT INCLUDED IN THE TRAINING AND WILL NOT BE AVAILABLE FOR USE OUTSIDE OF THE TRAINING ENVIRONMENT. THE TRAINEE MUST RETURN ALL PROPRIETARY MATERIALS RECEIVED DURING THE TRAINING AT THE END OF THE TRAINING. CUSTOMER ACKNOWLEDGES AND AGREES THAT NEITHER CUSTOMER NOR TRAINEE WILL RECEIVE A LICENSE TO SUCH PROPRIETARY MATERIALS AND THAT THE TRAINEE MAY NOT BE ABLE TO FULLY UTILIZE THE TRAINING WITHOUT THE USE OF SUCH PROPRIETARY MATERIALS. (CERTAIN LICENSES MAY BE OBTAINED THROUGH PURCHASE OF SUPPORT OR ASSIST AGREEMENT.) Course dates and location to be finalized by Philips. Philips shall attempt to accommodate Customer requested dates and training location. The price quoted includes course tuition. Travel and living expenses are not included, but may be purchased separately through Philips.

IMPORTANT Notes Regarding Admission to Philips Customer Engineer Training Courses:

1. Trainee must meet all prerequisites
2. Course expires one (1) year from equipment installation date (or purchase date if sold separately)
3. Customer must sign Philips Nondisclosure statement
4. Trainee must sign Philips Nondisclosure statement
5. Customer must sign Philips terms and conditions of training

Course Number:

XD3894

Course Title:

Allura Xper release 8.2 Essentials

CSIP Level:

All course materials are on CSIP level 1

100241 Allura Xper FD10

Line #	Part #	Description	Qty
--------	--------	-------------	-----

Course Length:

9 days

Delivery Method(s):

ILT

Modality:

iXR

Location:

PHC, CTC, SLC, HCA

Target Audience:

Field Service Engineers (multi-modality)

Licensed Representatives

System Code(s):

Associated system codes: 722-026, 722-027, 722-028, 722-029, 722-033, 722-034, 722-035, 722-036, 722-038, 722-039, 722-058, and 722-059

Document Date:

2015-05-26

**DESCRIPTION:**

After successfully finishing this training the Engineer reaches compliance to work on the above mentioned system codes. The training is performed on "basic" system configurations. Commercially available system options are only partially covered; these are offered as separate courses.

Aims of this training are :

- The engineer will learn how to:
- perform planned maintenance.
- execute a repair of the system.
- perform 1st line fault diagnosis on the system.

## 100241 Allura Xper FD10

Line #	Part #	Description	Qty
--------	--------	-------------	-----

Topics covered:

- Planned Maintenance
- plan visits
- perform preparation:
- customize planned maintenance modules
- determine visit type
- get latest planned maintenance instructions
- determine needed tools and materials
- operate the system; basic understanding of system operation
- use software service tools; field service framework and the Xper management tool on a basic level.
- perform the following planned maintenance instructions:
- general planned maintenance
- adjust generator, adjust image detector and perform level 1 Image Quality measurements
- adjust geometry
- patient support AD7X(N)T
- radiation safety
- electrical safety
- XtraVision release 8.8.1/9.0.x
- finishing activities

### Repair

For these repairs it is assumed that the fault diagnosis has been done by remote support, tier 2 or tier 3.

- Identify "all" Field Replaceable Units of the Allura Xper rel. 8.2 system
- Find the correct service instruction to replace a Field Replaceable Unit
- Identify connections between parts using the corrective maintenance manual
- Perform replacement cases; demonstrate replacement of various parts using the appropriate repair manual.

### First line fault diagnosis

Use the Corrective maintenance manual for faultfinding

- diagnostic flows (90%)
- functional diagrams (5%)
- led indications (5%)
- Learn how power is distributed
- Escalate to helpdesk
- Perform various fault finding cases
- power on problems
- movement problems
- acquisition problems

### PREREQUISITES:

All of the below courses:

**100241 Allura Xper FD10**

Line #	Part #	Description	Qty
		<ul style="list-style-type: none"> <li>FC9002 – Safety</li> <li>FC9003 – Imaging Systems Safety</li> <li>XD3007 – X-Ray Systems basic part 2</li> <li>XD9903 – Anatomy and pathology of the heart and bloodvessels</li> <li>XD9904 – Allura Xper Operation and Clinical Workflow</li> <li>FC9017 – Basic Networking</li> </ul>	

**COURSE OBJECTIVES:**

Upon successful completion of the course the learner will be able to:

- perform planned maintenance on the system according the planned maintenance instructions.
- execute a repair of the system with the help of available repair manuals.
- perform 1st line fault diagnosis on the system using the corrective maintenance manual.

<b>37</b>	<b>**989600213942</b>	<b>AD5 TO XPER TABLE ADAPT. PLATE</b>	<b>1</b>
-----------	-----------------------	---------------------------------------	----------

<b>38</b>	<b>SP003</b>	<b>Installation Labor</b>	<b>1</b>
		Remove and transport reuse items from University Hospital to CMC. Weekend equipment delivery with two weekends of installation labor	

<b>39</b>	<b>SP019</b>	<b>Trade in Allowance</b>	<b>1</b>
		Customer represents and warrants that (i) Customer has, and shall have when title passes, good and marketable title to the equipment being traded in and (ii) has the authority to effect such trade in. Product: Allura Xper FD10 Serial Number: Serial Number Not Provided Manufacturer:	

Trade-In authorization number: Trade-In Opportunity # 44311

Trade-In Value: \$10,700.00

De-install Date: 5/30/2017

Customer will be trading-in equipment that is described on the attached System Disclosure Form (the "Trade-In"), which Trade-In the parties agree (i) will be removed on the De-install Date and (ii) is currently in the condition as represented on the System Disclosure Form. In addition, the parties agree as follows:

- Customer represents and warrants that Customer has good and marketable title to the Trade-In as of the date of this Quotation and will have good and marketable title when Philips removes the Trade-In from Customer's site (the "Removal Date");
- Title to the Trade-In shall pass from Customer to Philips on the Removal Date, unless otherwise agreed by Philips and the Customer;
- Notwithstanding anything to the contrary in any Business Associate Addendum, Customer represents and warrants that as of the Removal Date all Protected Health Information will have been de-identified or removed from the Trade-In;

**100241 Allura Xper FD10**

Line #	Part #	Description	Qty
--------	--------	-------------	-----

4. Philips may test and inspect the Trade-In prior to de-installation. If the condition of the Trade-In is not substantially the same on the Removal Date (ordinary wear and tear excepted) as it is identified on the System Disclosure Form, then Philips may reduce the price quoted for the Trade-In;
5. If the removal date is delayed until after the De-Install Date, unless Philips causes the delay, then Philips may reduce the price quoted for the Trade-In by six percent (6%) per month.
6. Philips is responsible for normal de-installation costs of the Trade-In.
7. The trade-in value will not include costs associated for any facility modifications and/or rigging required for de-installation and must be accounted for separately.
8. Customer is responsible for all plumbing necessary to properly drain coolant from chiller system and cap the lines.
9. Prior to the Removal Date, Customer shall remove from the room all equipment that is not being de-installed.

\*\*\*\*\*PROMOTIONS\*\*\*\*\*

Promotion Name	Description
----------------	-------------

Monoplane Closer Promo 2017Q3	Philips is pleased to offer this special promotional discount of \$50,000 on the purchase of a monoplane interventional x-ray system. To take advantage of this promotion, customer orders must be placed prior to September 30, 2017.
-------------------------------	--

ClarityIQ New and Refurbished System Promo 2017Q3	Philips is pleased to offer this special \$55,000 discount for customers purchasing systems with ClarityIQ. To take advantage of this promotion, customer orders must be placed prior to September 30, 2017.
---	--

NET PRICE

\$862,279.98

Buying Group: CAROLINAS HEALTHCARE SYSTEM SCA

Contract #: CAA0013200

Add'l Terms:

Each Quotation solution will reference a specific Buying Group/Contract Number representing an agreement containing discounts, fees and any specific terms and conditions which will apply to that single quoted solution. If no Buying Group/Contract Number is shown, Philips' Terms and Conditions of Sale will apply to the quoted solution.

Each equipment system listed on purchase order/orders represents a separate and distinct financial transaction. We understand and agree that each transaction is to be individually billed and paid.

Price above does not include any applicable sales taxes.

The preliminary delivery request date for this equipment is: \_\_\_\_\_.

If you do not issue formal purchase orders indicate by initialing here \_\_\_\_\_.

Tax Status:

Taxable \_\_\_\_\_ Tax Exempt \_\_\_\_\_

If Exempt, please indicate the Exemption Certification Number: \_\_\_\_\_, and attach a copy of the certificate.

Delivery/Installation Address:

Invoice Address:

\_\_\_\_\_  
\_\_\_\_\_  
\_\_\_\_\_

\_\_\_\_\_  
\_\_\_\_\_  
\_\_\_\_\_

Contact Phone #:

Contact Phone #:

\_\_\_\_\_

\_\_\_\_\_

Purchaser approval as quoted:

Date:

\_\_\_\_\_

\_\_\_\_\_

Title:

\_\_\_\_\_

This quotation is signed and accepted by an authorized representative in acknowledgement of the system configuration, terms and conditions stated herein.

**OPTIONS**

SELECTION OF ANY OPTION WILL INCREASE THE CONTRACT PRICE BY THE AMOUNT SHOWN IN THE PRICE COLUMN. OPTIONAL EQUIPMENT PRICING VALID ONLY IF PURCHASED IN CONJUNCTION WITH EQUIPMENT QUOTED.

Line #	Part #	Description	Qty	Each	Price	Initial
1	**NCVA672	FD SmartMask	1	\$13,566.34	\$13,566.34	_____

SmartMask simplifies roadmapping procedures by overlaying a selected reference image with fluoroscopy on the live monitor in the exam room.  
 The reference image can be faded in/out with variable intensity, controlled from tableside.  
 SmartMask uses the reference image displayed on the reference monitor.  
 Any previously acquired image can be used as reference.

SmartMask facilitates pre- and post- intervention comparisons to assess treatment results

2	**NCVB882	Cradle extension	1	\$18,961.04	\$18,961.04	_____
---	-----------	------------------	---	-------------	-------------	-------

- Moves the tabletop in a cradle motion from side to side to support surgical and puncture procedures
- Improves access to patients
- Allows precise imaging of contrast medium or blood

**Precise imaging during surgery and puncture procedures**

To obtain high quality imaging results and help in avoiding re-takes during surgical or puncture procedures, it can be useful to swing the tabletop from side to side in a cradle movement. This extension moves the tabletop in a cradle motion to improve access to patients. It also allows precise imaging of contrast medium or blood.

# PHILIPS PRODUCT WARRANTY

## CARDIOVASCULAR SYSTEMS (CV)

This product warranty document is an addition to the terms and conditions set forth in the quotation to which this warranty document is attached. Unless specifically listed below, this warranty does not apply to replacement parts. The terms and conditions of the quotation are incorporated into this warranty document. The capitalized terms herein have the same meaning as set forth in the quotation.

### **1. Twelve (12) Month System Warranty**

1.1 Philips Healthcare a division of Philips North America LLC ("Philips") warrants to Customer that the Philips Cardio Vascular Systems ("System") will perform in substantial compliance with its performance specifications, in the documentation accompanying the System, for a period of twelve (12) months after completion of installation or availability for first patient use, whichever occurs first.

1.2 Any glassware or flat detectors provided with the System is subject to special warranty terms set forth below.

### **2. Planned Maintenance**

2.1 During the warranty period, Philips service personnel will schedule planned maintenance visits, in advance, at a mutually agreeable time on weekdays, between 8:00 A.M. and 5:00 P.M. local time, excluding Philips observed holidays.

### **3. System Options, Upgrades or Accessories**

3.1 Any Philips authorized options, upgrades, or accessories for the System which are delivered and/or installed on the System during the original term of the System warranty shall be subject to the same warranty terms contained in the first paragraph of this warranty, except that such warranty shall expire on the later of: (a) upon termination of the initial twelve (12) month warranty period for the System on which the option or accessory is installed, b) after ninety (90) days for parts only from the date of installation.

### **4. MRC X-ray TUBES**

4.1 Philips warrants to Customer, for the warranty periods further specified in this section, that the Philips X-Ray tube will be substantially free from defects in material and manufacturing workmanship, which impair performance under normal use as specified in Philips System descriptions and specifications.

4.2 The warranty period for MRC tubes provided with Customer's purchase of a new or refurbished X-ray system shall be the shorter of thirty-six (36) months after installation or thirty-eight (38) months after date of shipment from Philips.

4.3 The warranty period for purchases of replacement tubes shall be the shorter of twelve (12) months after installation or fourteen (14) months after date of shipment from Philips.

### **5. MRC Tube Warranty Exclusion**

5.1 The above warranty shall not apply to X-ray tubes outside the United States and Canada.

5.2 Philips obligations under the System warranty do not apply to any System defects resulting from: improper or inadequate maintenance or calibration by Customer or its agents; Customer or third party supplied software, interfaces, or supplies; use or operation of the System other than in accordance with loss, or damage in transit; improper site preparation; unauthorized maintenance or Philips applicable System specifications and written instructions; abuse, negligence, accident, modifications to the System; or, to viruses or similar software interference resulting from the connection of the System to a network.

### **6. MRC Tube Warranty Remedies**

6.1 If a tube is found to fail during the warranty period, and if, in the best judgment of Philips, the failure is not due to neglect, accident, improper installation, use contrary to instructions, or the exclusions stated above, Philips tube warranty liability hereunder is limited to, at Philips option, the repair or replacement of the tube.

6.2 Any replacement tube would have a warranty period equal to the balance of the warranty period left on the tube replaced.

### **7. Dynamic Flat Detectors**

7.1 Philips warrants the flat detectors provided with the System, if any, will be free from defects in material and manufacturing workmanship for twelve (12) months.

7.2 Claims must be made within twelve (12) months after installation or fifteen (15) months after date of shipment from Philips, whichever occurs first.

7.3 If a detector fails to meet this warranty, as Customer's sole and exclusive remedy, upon return of the detector, Philips will provide Customer a replacement detector at no additional charge.

### **8. System Software and Software Updates**

8.1 The software provided with the System will be the latest version of the standard software available for that System as of the ninetieth (90th) day prior to the date the System is delivered to Customer.

8.2 Updates to standard software for the System that do not require additional hardware or equipment modifications will be performed as a part of normal warranty service during the term of the warranty.

8.3 All software is and shall remain the sole property of Philips or its software suppliers.

8.4 Use of the software is subject to the terms of a separate software license agreement. Customer must sign all such license agreements prior to or upon the delivery of the product.

8.5 No license or other right is granted to Customer or to any other party to use the software except as set forth in the license agreements.

8.6 Any Philips maintenance or service software and documentation provided with the System and/or located at Customer's premises is intended solely to assist Philips and its authorized agents to install and to test the System, to assist Philips and its authorized agents to maintain and to service the System under a separate support agreement with Customer, or to permit Customer to maintain and service the System.

8.7 Customer agrees to restrict the access to such software and documentation to Philips employees, those of its authorized agents, and to authorized employees of Customer only.

### **9. Warranty Limitations**

9.1 Philips sole obligations and Customer's exclusive remedy under any product warranty are limited, at Philips option, to the repair or the replacement of the product or a portion thereof, within thirty (30) days after receipt of written notice of such material breach from Customer ("Product Warranty Cure Period") or, upon expiration of the Product Warranty Cure Period, to a refund of a portion of the purchase price paid by the Customer upon Customer's request.

9.2 Any refund will be paid, to the Customer when the product is returned to Philips.

9.3 Warranty service outside of normal working hours (i.e. 8:00 AM to 5:00 PM, Monday through Friday, excluding Philips Observed holidays), will be subject to payment by Customer at Philips standard service rates.

9.4 This warranty is subject to the following conditions: the product (a) is to be installed by authorized Philips representatives (or is to be installed in accordance with all Philips installation instructions by personnel trained by Philips); (b) is to be operated exclusively by duly qualified personnel in a safe and reasonable manner in accordance with Philips written instructions and for the purpose for which the products were intended; and (c) is to be maintained and in strict compliance with all recommended and scheduled maintenance instructions provided with the Product.

9.5 Philips' obligations under any product warranty do not apply to any product defects resulting from: improper or inadequate maintenance or calibration by the Customer or its agents; Customer or third party supplied interfaces, supplies, or software including without limitation loading of operating system patches to the Licensed Software and/or upgrades to anti-virus software running in connection with the Licensed Software without prior approval by Philips; use or operation of the product other than in accordance with Philips' applicable product specifications and written instructions; abuse, negligence, accident, loss, or damage in transit; improper site preparation; unauthorized maintenance or modifications to the product; or, viruses or similar software interference resulting from connection of the product to a network.

9.6 Philips does not provide a warranty for any third party products furnished to Customer by Philips under this quotation; however, Philips shall use reasonable efforts to extend to Customer the third party warranty for the product.

9.7 The obligations of Philips described herein and in the applicable product-specific warranty document are Philips only obligations and Customer's sole and exclusive remedy for a breach of a warranty.

9.8 THE WARRANTIES SET FORTH HEREIN AND IN PHILIPS WARRANTY DOCUMENT WITH RESPECT TO A PRODUCT (INCLUDING THE SOFTWARE PROVIDED WITH THE PRODUCT) ARE THE ONLY WARRANTIES MADE BY PHILIPS IN CONNECTION WITH THE PRODUCT, THE SOFTWARE, AND THE TRANSACTIONS CONTEMPLATED BY THE QUOTATION, AND ARE EXPRESSLY IN LIEU OF ANY OTHER WARRANTIES, WHETHER WRITTEN, ORAL, STATUTORY, EXPRESS OR IMPLIED INCLUDING, WITHOUT LIMITATION, ANY WARRANTY OF NON-INFRINGEMENT MERCHANTABILITY OR FITNESS FOR A PARTICULAR PURPOSE.

9.9 Philips may use refurbished parts in the manufacture of the products, which are subject to the same quality control procedures and warranties as for new parts.

### **10. Remote Services Network ("RSN")**

10.1 Customer will (a) provide Philips with a secure location at Customer's premises to store one Philips remote services network router and provide full and free access to this router, (or a Customer-owned router acceptable to Philips) for connection to the equipment and to Customer's network; or (b) provide Philips with outbound internet access over SSL; at all times during the warranty period provide full and free access to the equipment and the Customer network for Philips use in remote servicing of the product, remote assistance to personnel that operate the products, updating the product and regular uploading of products data files (such as but not limited to error logs and utilization data for improvement of Philips products and services and aggregation into services).

10.2 Customer's failure to provide such access will constitute Customer's waiver of the scheduled planned maintenance service and will void support or warranty coverage of product malfunctions until such time as planned maintenance service is completed or RSN access is provided.

10.3 Customer agrees to pay Philips at the prevailing demand service rates for all time spent by Philips service personnel waiting for extended coverage.



**11. Transfer of System**

11.1 In the event Customer transfers or relocates the System, all obligations under this warranty will terminate unless Customer receives the prior written consent of Philips for the transfer or relocation.

11.2 Upon any transfer or relocation, the System must be inspected and certified by Philips as being free from all defects in material, software and workmanship and as being in compliance with all technical and performance specifications.

11.3 Customer will compensate Philips for these services at the prevailing service rates in effect as of the date the inspection is performed.

11.4 Any System which is transported intact to pre-approved locations and is maintained as originally installed in mobile configurations will remain covered by this warranty.

**12. Limitation of Liability**

12.1 THE TOTAL LIABILITY, IF ANY, OF PHILIPS AND ITS AFFILIATES FOR ALL DAMAGES AND BASED ON ALL CLAIMS, WHETHER ARISING OR RELATING TO FROM BREACH OF CONTRACT, BREACH OF WARRANTY, NEGLIGENCE, INDEMNITY, STRICT LIABILITY OR OTHER TORT, OR OTHERWISE, ARISING FROM A PRODUCT, LICENSED SOFTWARE, AND/OR SERVICE IS LIMITED TO THE PRICE PAID HEREUNDER FOR THE PRODUCT, LICENSED SOFTWARE, OR SERVICE GIVING RISE TO THE LIABILITY.

12.2 THIS LIMITATION SHALL NOT APPLY TO:

(a) THIRD PARTY CLAIMS FOR DIRECT DAMAGES FOR BODILY INJURY OR DEATH TO THE EXTENT CAUSED BY PHILIPS NEGLIGENCE OR PROVEN PRODUCT DEFECT.

(b) CLAIMS OF TANGIBLE PROPERTY DAMAGE REPRESENTING THE ACTUAL COST TO REPAIR OR REPLACE PHYSICAL PROPERTY TO THE EXTENT CAUSED BY PHILIPS NEGLIGENCE OR PROVEN PRODUCT DEFECT;

(c) OUT OF POCKET COSTS INCURRED BY CUSTOMER TO PROVIDE PATIENT NOTIFICATIONS, REQUIRED BY LAW, TO THE EXTENT SUCH NOTICES ARE CAUSED BY PHILIPS UNAUTHORIZED DISCLOSURE OF PHI, and;

(d) FINES/PENALTIES LEVIED AGAINST CUSTOMER BY GOVERNMENT AGENCIES CITING PHILIPS UNAUTHORIZED DISCLOSURE OF PHI AS THE BASIS OF THE FINE/PENALTY, ANY SUCH FINES OR PENALTIES SHALL CONSTITUTE DIRECT DAMAGES.

**13. Disclaimer**

13.1 IN NO EVENT SHALL PHILIPS OR ITS AFFILIATES BE LIABLE FOR ANY INDIRECT, PUNITIVE, INCIDENTAL, CONSEQUENTIAL, EXEMPLARY OR SPECIAL DAMAGES, INCLUDING WITHOUT LIMITATION, LOST REVENUES OR PROFITS, BUSINESS INTERRUPTION, LOSS OF DATA OR THE COST OF SUBSTITUTE PRODUCTS OR SERVICES WHETHER ARISING FROM BREACH CONTRACT, BREACH OF WARRANTY, NEGLIGENCE, INDEMNITY, STRICT LIABILITY OR OTHER TORT.

**14. FORCE MAJEURE**

14.1 Philips and Customer shall each be excused from performing its obligations arising from any delay or default caused by events beyond its reasonable control including, but not limited to: acts of God, acts of third parties, acts of the other party, acts of any civil or military authority, fire, floods, war, embargoes, labor disputes, acts of sabotage, riots, accidents, delays of carriers, subcontractors or suppliers, voluntary or mandatory compliance with any government act, regulation or request, shortage of labor, materials or manufacturing facilities.

Philips system specifications are subject to change without notice



# Making the difference with Philips Live Image Guidance

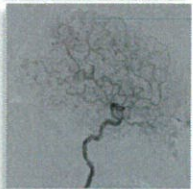

Philips AlluraClarity family

# PHILIPS

EXHIBIT

tabbles

7B



## Making the difference with Philips Live Image Guidance

Together we make the difference in minimally invasive treatment to enhance patient outcomes and save lives. With our Live Image Guidance we aim to remove barriers to effective and reproducible treatments, delivering relevant clinical value where it's needed most - at the point of patient treatment.

Intelligent and intuitive integration of live imaging, patient information, and disease-centric tools help to augment therapy guidance. Our AlluraClarity family with Clarity/Q technology enables physicians to deliver fast and confident diagnosis, simplified procedures and an efficient clinical workflow. All while providing high quality imaging at low dose levels.

Together, we open doors to new procedures and techniques that truly make a difference to people's lives while driving growth and reducing the cost of care.

### Key benefits

- Find and treat the problem with greater insight and confidence
- Enhance of user experience to promote consistency and efficiency
- Lower barriers for minimally invasive interventions
- Increased economic value in your investment

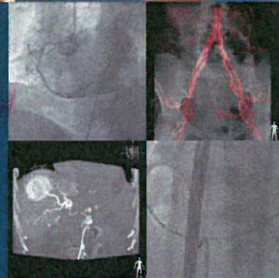

Delivering relevant clinical value where it's needed most 4

As our most powerful interventional X-ray system yet, AlluraClarity delivers clinical value where it's needed most: at the point of patient treatment.

Our AlluraClarity family 18

A comprehensive and powerful range of solutions to address your clinical needs and help you open doors to new procedures and techniques.

Increased Economic Value 28

Our flexible service contracts are tailored to your budget to protect your investment by providing easy access to the latest upgrades and innovations.

## Delivering relevant clinical value where it's needed most

As our most powerful interventional X-ray system yet, AlluraClarity delivers relevant clinical value where it's needed most – at the point of patient treatment. With advanced Live Image Guidance, you benefit from high-definition, high-quality images of even the smallest vessels, disease-specific tools, and intelligent, intuitive integration of patient information.

With our new AlluraClarity family, you can now perform complex procedures with confidence.

### Find and treat the problem with greater insight and confidence

Our Live Image Guidance expands clinical capabilities through intelligent and intuitive integration of multi-modality images at the point of treatment. This enables confident diagnosis and real-time therapy monitoring.

### Optimization of user experience to promote greater consistency and efficiency

We are committed to enhancing the user experience to support the clinician in each of their specific procedures by combining disease-centric tools, patient data and procedural protocols in a single suite. This simplifies clinical workflows and promotes efficiency.

### Lower barriers for minimally invasive interventions

We have a long-standing commitment and philosophy to manage dose through a set of techniques, programs and practices that focus on providing excellent image quality.

### Increased economic value

We provide full support throughout the whole lifecycle of your interventional suite, providing investment protection by increasing uptime and giving you easy access to the latest upgrades and innovations. Our service contracts portfolio offers a comprehensive range of flexible coverage that aligns with your budget and in-house capabilities.

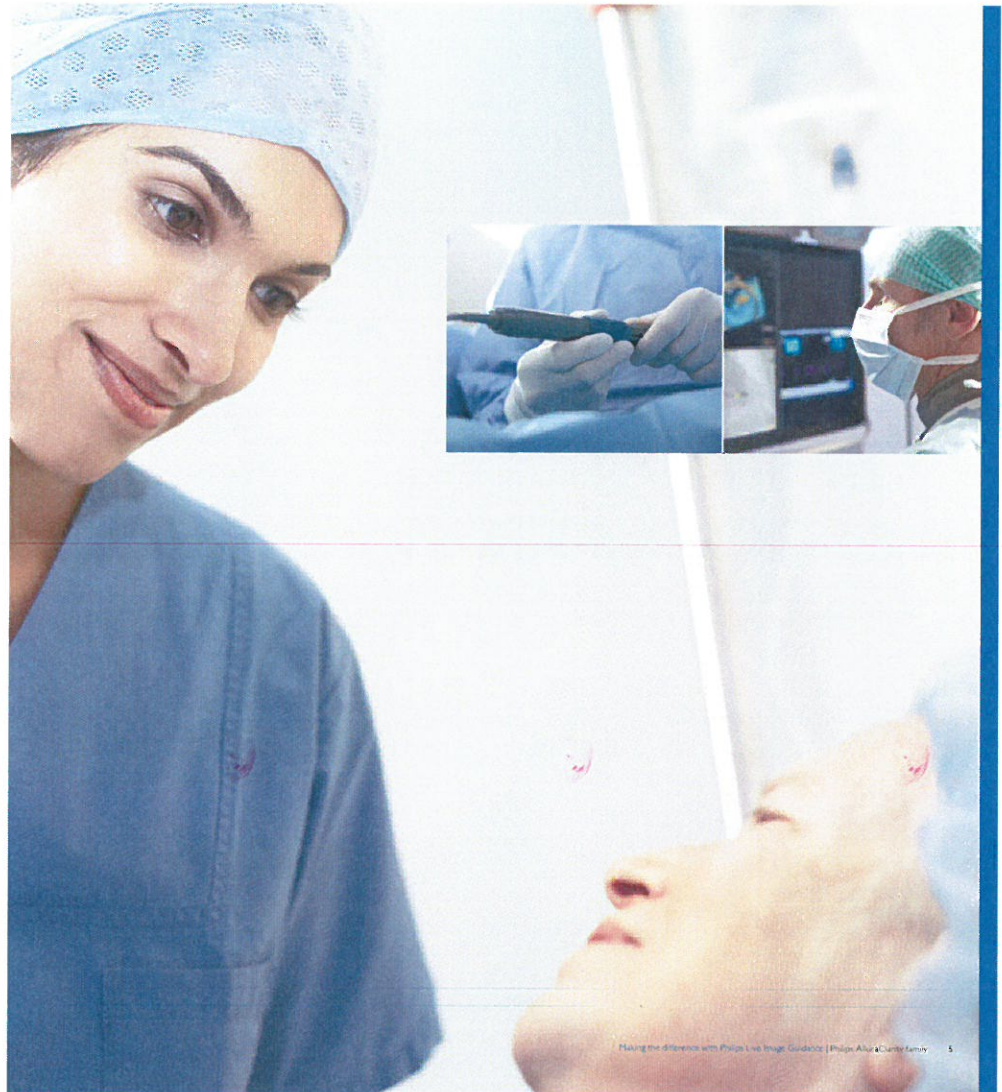

# See with confidence - every time.

**AlluraClarity with ClarityIQ technology**  
ClarityIQ is our breakthrough technology which maintains image quality while managing dose. Leveraging our imaging expertise and excellent technology, we collaborated with top interventional physicians in the development of ClarityIQ technology. Together, we redesigned the entire digital imaging pipeline.

The result is high quality imaging for a full range of clinical procedures at low dose levels.

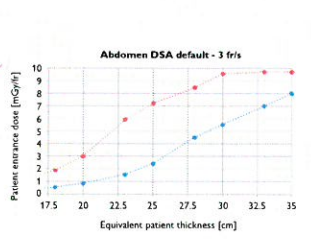
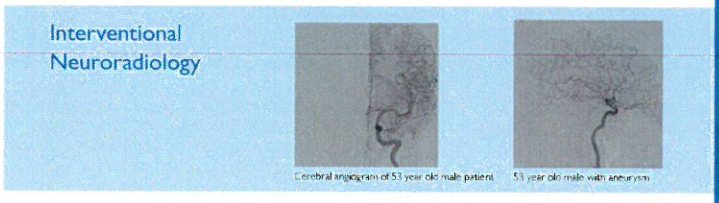
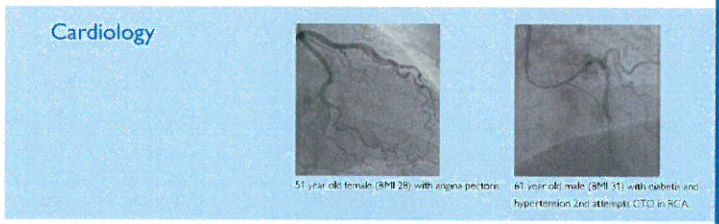
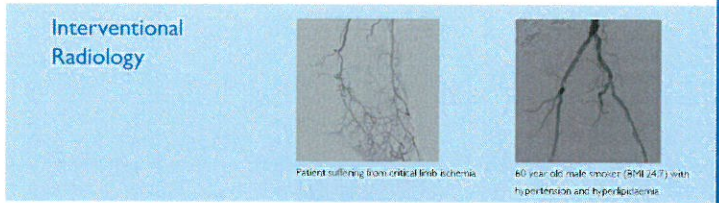
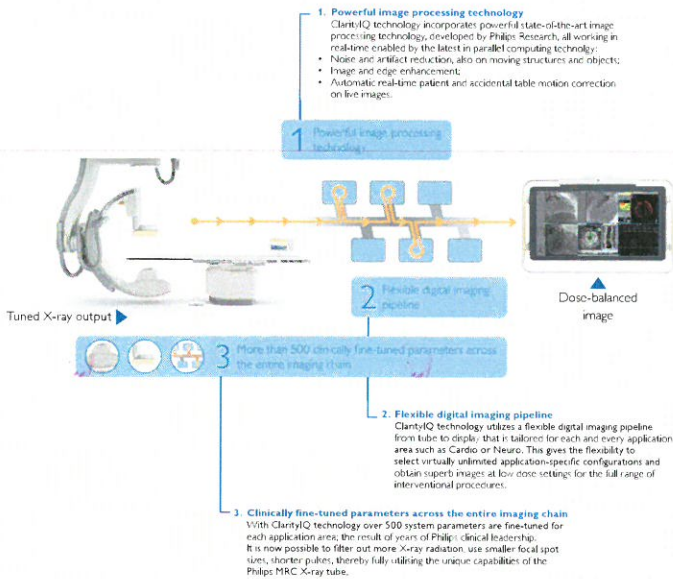

Patient entrance dose vs. equivalent patient thickness Abdomen DSA

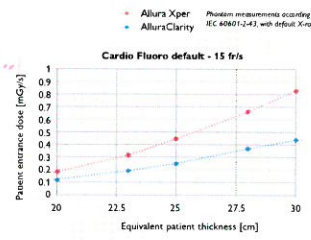

Patient entrance dose vs. equivalent patient thickness Cardio Fluoro

# Pushing the boundaries of ALARA

Our AlluraClarity family with ClarityIQ technology is the latest breakthrough in our commitment to manage radiation exposure for patients and clinical staff. It sets a new standard by pushing the boundaries of ALARA (As Low As Reasonably Achievable). ClarityIQ maintains equivalent image quality at low dose. This may help remove dose as a barrier to new procedures and techniques.

### Philips DoseAware family

Real-time dose feedback to increase radiation awareness and promote healthy working practices.

Philips DoseAware® family of real-time dose feedback tools is designed to make it easy for people working in X-ray environments to monitor their radiation exposure in daily work and adopt healthier working practices.

DoseAware Xtend® is a dedicated solution for rooms with Philips FlexVision XL display. Its integration with the Allura X-ray system allows it to provide detailed feedback on scattered X-ray dose levels per procedure.

DoseAware can be used in any X-ray room to provide real-time feedback on scattered X-ray exposure so staff can immediately adjust their working habits to manage radiation exposure.

\* These products do not replace the thermoluminescent dosimeter (TLD) as a legal dose meter.

### Increases radiation awareness

- Gives you the cumulative amount of X-ray dose received right after each procedure
- Reminds you to take secondary lead precautions
- Sends you weekly or monthly reports automatically on your procedure-based staff dose to help you identify your individual exposure trends
- Sends procedural data on X-ray dose in DICOM RDSR format to PACS or RIS to simplify data analysis

### Advantages of a real-time dose meter

- Gives you the information you need to manage your own X-ray dose exposure
- You see when and where X-ray dose was acquired so you can act appropriately
- You can easily check your exposure level on the colored display in the examination room
- Facilities can archive, report, and analyze radiation data to maintain high levels of occupational safety

### SpectraBeam Intelligence

Using SpectraBeam, AlluraClarity helps to manage dose by taking a more intelligent approach to the use of x-rays. To this end, the AlluraClarity uses special SpectraBeam filters in fluoro and exposures to remove unwanted 'soft' radiation, i.e. those X-rays that hit the patient but do not have enough energy to reach the image detector. The soft radiation is replaced by higher-energy radiation which increases image quality. Alternatively, you can 'trade off' some of this increased quality to further manage dose.

"DoseAware is one of the most important new tools available to help reduce occupational medical radiation exposure to physicians and staff. It's a much easier and practical way to monitor levels than conventional methods. Creating a better work environment is not only the right thing to do but our obligation."

J. Kah, MS, RN Lab Manager, Director, Cardiac and Vascular Services, Baptist Cardiac & Vascular Institute, Miami, USA

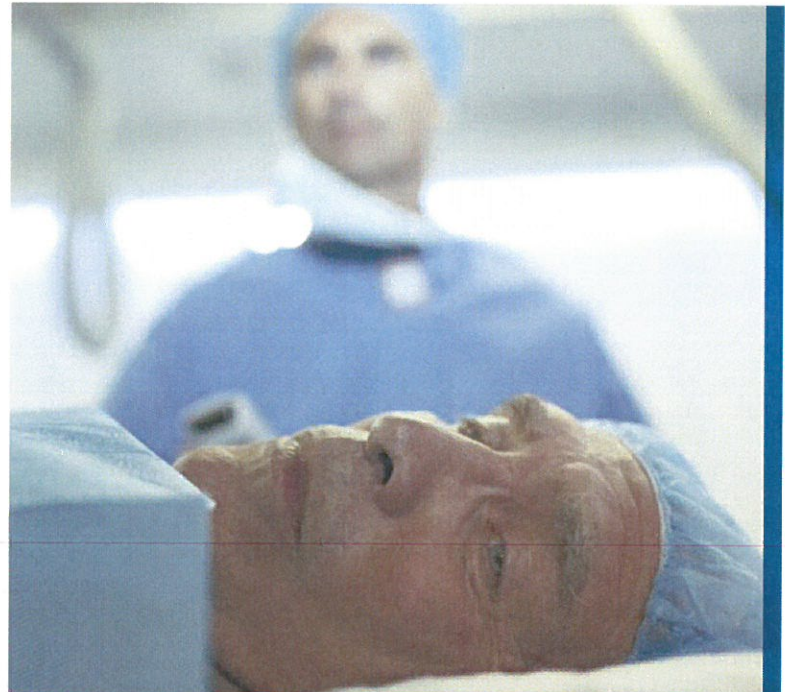

### DoseWise

Our long-standing commitment to manage dose is focused in DoseWise, a set of software programs and protocols that focus on providing excellent image quality while maximizing the safety of patients and clinical staff in X-ray environments. DoseWise has the three pillars - Smart Beam, less time and more awareness - and is integrated into every level of our new product development.



# Transforming minimally invasive therapy

The AlluraClarity family is based on our industry-leading Live Image Guidance. Enabling fast and effective treatments, this advanced technology helps you to transform minimally-invasive therapies. With specific solutions for the treatment of cardiac and vascular diseases, you can open doors to new procedures and techniques, all while enhancing your interventional lab.

Our Live Image Guidance is complemented by advanced interventional tools, seamlessly integrated into the AlluraClarity family, to support your clinical workflow. Further support is provided by our comprehensive

clinical, technical and education programs. Strong partnerships with a worldwide network of clinical experts and customers have driven development of our Live Image Guidance technology. This has given us the opportunity to quickly address your changing needs and deliver truly meaningful innovation where it really matters – at the point of patient treatment.

Together, we drive growth and open doors to new procedures and techniques that truly make a difference in people's lives.



## Treating cardiac diseases

From routine coronary heart disease to the most complex structural heart disease, congenital heart disease, cardiac surgery and ablation procedures, our AlluraClarity family with ClarityQ technology enables clinicians to deliver fast, effective and simplified procedures with an efficient clinical workflow. Intuitive, procedure specific tools, integrated X-ray, multi-modality imaging, and patient information are combined

in an interventional lab or hybrid surgical suite. Quick and easy access to enhanced visualization and live navigation through soft tissue anatomy helps physicians to determine the excellent course of treatment with confidence. With AlluraClarity you can also realize high image quality with low dose settings, helping to manage exposure to patients and staff.

### Coronary artery disease



**XperSwing**  
Achieve all desired anatomical views in a single X-ray run for a complete visualization of complex coronary vasculatures as a result it manages radiation exposure.

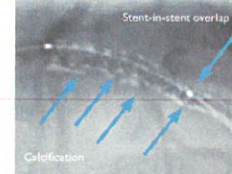

**StentBoost**  
Clearly visualize stents during positioning and deployment.



**Integrated solutions**  
Gain immediate access to all required information such as hemodynamics, FFR, IVUS, OCT, NIRS in an easy and direct way.

### Structural heart disease



**CX50**  
High performance, compact ultrasound system that is seamlessly integrated with the AlluraClarity platform to enhance workflow. Also available with live 3D-TFF and ICE at table-top.

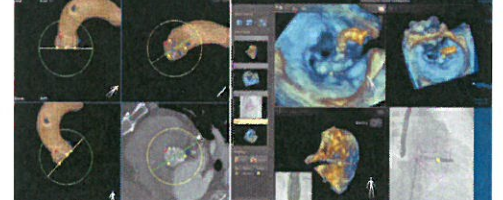

**HeartNavigator**  
Simplifies planning, device selection, and choice of excellent X-ray viewing angle. Provides additional live 3D imaging guidance during device placement. Also gives insight into calcified plaque distribution in the ascending aorta and orifice of the coronary.

**EchoNavigator**  
Allows visualization of both devices and soft tissues which may provide confidence in performing complex structural heart interventions.

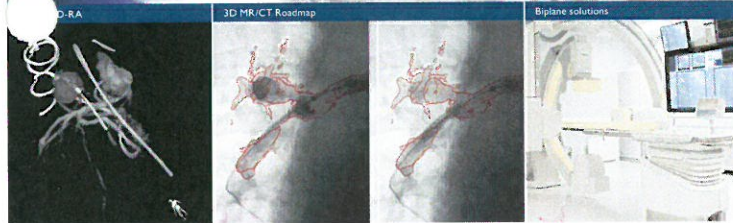

3D visualization in a single rotation for assessment of complex anatomical structures, allowing you to plan the excellent therapeutic approach.

Live overlay on 3D MR/CT Roadmap roadmap enhances visualization of anatomical structures and device navigation by re-using preoperative CT or MR angiographic images.

Our unique double C-arm allows steep lateral projections for complex anatomy without compromising accessibility.

**Congenital heart disease**

With access to enhanced live visualization and navigation you can confidently determine an excellent course of treatment. Intuitive, pediatric-specific tools, integrated multi-modality imaging, and patient information are combined in an interventional lab or hybrid surgical suite.

Our AlluraClarity family with ClarityQ technology delivers high image quality at low dose settings for the full range of interventional procedures, while our other Live Image Guidance tools like MR/CT Roadmap enhance visualization for better navigation.

**Cardiac arrhythmia**

Intelligent and intuitive integration of multi-modality imaging, recording, mapping, robotics and IT applications provides you with ease of use, allowing you to streamline your workflow for enhanced lab efficiency. Our advanced 3D imaging tools give you insight into complex cardiac anatomies, and help you to navigate your catheters with confidence.

Whether performing an AFib ablation procedure or implanting a CRT device, our AlluraClarity family with ClarityQ technology enables physicians to deliver fast, effective and simplified electrophysiology procedures with an efficient clinical workflow, all while delivering high image quality at low dose settings for the full range of interventional procedures.



EP Navigator

EP Cockpit

Equipment rack



Intuitive 3D catheter guidance using precisely registered 3D cardiac anatomy and 2D fluoroscopy images. Its utility has been demonstrated in clinical studies.<sup>1,2,3</sup>

Easy operation of multi-vendor equipment in the control room, and flexible viewing in the exam room.

Clutter-free integration of 3rd party equipment.

3D rotational scan



Advanced 3D imaging to acquire LA-PV anatomy at the time of the procedure with excellent scan trajectory.<sup>4</sup>





The only high-performance, compact ultrasound system that seamlessly integrates with the AlluraClarity platform to enhance workflow.

Navigate through complex vasculature with live 3D image guidance by re-using CT or MR angiography images.

Philips' next generation XperCT helps clinicians to assess treatment options and results within the Intra-embolal Suite without transporting the patient. Now with fast protocols (~5 sec) and Metal artifact and BML noise reduction capabilities.

**Treating vascular diseases**

With our Live Image Guidance we aim to lower barriers to effective and reproducible treatments, delivering relevant clinical value where it's needed most – at the point of patient treatment.

**Endovascular interventions**

Intelligent and intuitive integration of multi-modality imaging, patient information, and procedure specific applications deliver critical information to enhance real time guidance through complex vasculature and visualize tissue perfusion to identify treatment end-

point in peripheral vascular interventions. This results in a correction in the initial treatment strategy in up to 60% of the cases in patients with critical limb ischemia and non-healing tissue lesions.<sup>1</sup> Whether treating critical limb ischemia or embolizing a uterine fibroid, our AlluraClarity family with ClarityQ technology enables physicians to deliver fast, effective and simplified procedures with an efficient clinical workflow. All while delivering high quality imaging at ultra-low dose levels for patients of all sizes.

**Oncology interventions**

Intelligent and intuitive integration of multi-modality imaging, patient information and procedure-specific applications help enhance intra-arterial interventions by delivering enhanced lesion detection as compared to standard DSA<sup>2</sup> and comparable to MR<sup>3</sup> and conventional CT. Visualize and understand the nature and location of the lesion to effectively plan the most appropriate treatment. Leverage 3D information to reveal small Hepatocellular Carcinomas (HCCs) and their

feeding arterial anatomy<sup>4</sup> and to provide early intra-op assessment of therapy response after trans-arterial chemo-embolization. Whether you are ablating or embolizing a tumor, our AlluraClarity family with ClarityQ technology enables physicians to deliver fast, effective and simplified procedures with a more efficient clinical workflow. All while delivering high image quality at low dose settings for the full range of interventional procedures.

"What's changed with AlluraClarity is that everyone wants to work in that room"

Dr. B. Katzen, Baptist Cardiac and Vascular Institute Miami, FL USA

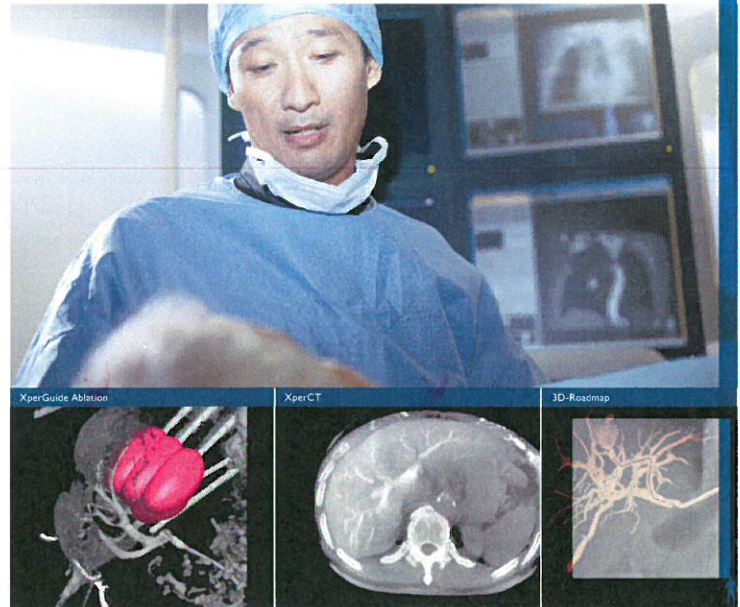

Plan enhanced tumor coverage by visualizing the thermal characteristics of the ablation device.

Fast detection and reconstructions (~5sec) of contrast-enhanced lesions and their feeding vessels in 3D.

Identify and target feeding tumor vessels on 3D Roadmap.

**FlexVision XL**

See sub-millimeter perforators and vessels at the capillary level in 2D and 3D. Flexible switching of video sources, as well as easy switching of screen layouts and image sizes from the table-side, enhances workflow.

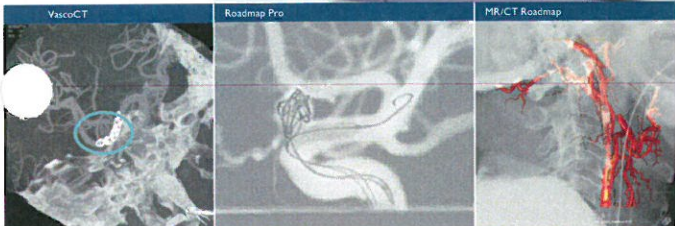

Visualize location, size and direction of an occlusion when dealing with an ischemic stroke.

Confidently navigate in 2D with customized settings for each endovascular material.

Navigate in 3D using real-time, motion-compensated MR/CT images.

**Neuro Interventions**

Intelligent and intuitive integration of multi-modality imaging, acquired images of cerebral vessels and devices and procedure specific applications may help enhance real-time decision making through visualization, live navigation and immediate therapy feedback. Quickly assess the problem and confidently target the affected lesion while preserving healthy tissue. Whether

delicately maneuvering through complex anatomy to treat an aneurysm or racing the clock to remove a clot, our AlluraClarity family with ClarityQ technology enables physicians to deliver fast, effective and simplified procedures for an efficient clinical workflow. All with high image quality and low dose settings.

**Hybrid suite**

Intelligent and intuitive integration of live imaging, patient information, and disease-centric tools in a single hybrid suite enables physicians to quickly and confidently determine the excellent course of treatment across a broad range of procedures. Move from EVAR stenting to a TAVI case or a Neurosurgery procedure and perform endovascular as well as hybrid and open surgery in a single suite.

Our FlexMove simplifies procedures and the transitions between them to increase lab utilization while our AlluraClarity family with ClarityQ technology enables physicians to deliver fast, real time therapy guidance delivering high image quality at low dose settings for the full range of interventional procedures.

**FlexMove**

With FlexMove, you can easily move the C-arm anywhere it's required around the table – and then conveniently park it out of your way entirely when it's not required during open surgery. This gives the team more flexibility to work around the patient and outstanding access at the head area allowing the anesthesiologist to work with ease.

Features like these, combined with the low dose levels possible with AlluraClarity, means long and often complex procedures can be carried out with a higher degree of comfort.

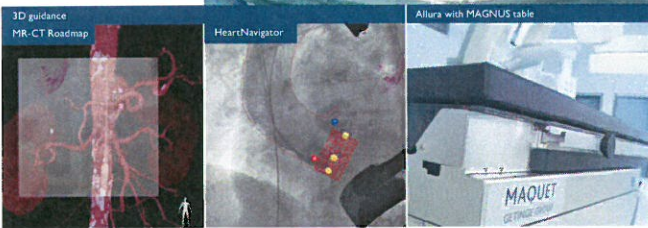

Through innovations like 3DRA, XperCT, MR-CT Roadmap and HeartNavigator you can work with new confidence. By having access to high-quality images, unique 3D capabilities and innovative imaging solutions, you have invaluable support in the planning, visualization, and live guidance of even the most challenging procedures.

The Allura MAGNUS combination seamlessly integrates best-in-class interventional X-ray with a best-in-class OR table for a truly multifunctional room suitable for conventional surgery, hybrid surgery or interventions. The Allura and MAGNUS table are completely synchronized, so you benefit from automatic position control (APC), bolus chase procedure and 3D software tools.



## Our AlluraClarity family

Our AlluraClarity family offers a powerful and comprehensive range of solutions to address all your clinical needs - opening the doors to new procedures and techniques.

Bi-plane stand



Ceiling-mounted stands



Floor-mounted stands



Flexibility with interventional tables



Performing complex interventions with confidence has always required a clear view of vessel morphology. Now this clear view also comes with a host of efficiency and clinical performance enhancements. Introducing the next generation of AlluraClarity biplane stand systems. With integrated Live image guidance these represent some of the most advanced systems available, offering excellent insight for confidence and decision-making during complex interventions.

The ceiling-mounted X-ray system gives you the flexibility to access the patient from three sides of the table, supporting a full range of interventional workflows. The rock-solid stand design combines fast movements with excellent control. The stand, monitor suspension and operating modules can be freely positioned for different lab set-ups. There is extra parking at the foot end to free up access to the patient when required.

The floor-mounted X-ray system is suitable for virtually any room and any procedure. You can free up the area around the head, while benefiting from full body coverage as needed.

Our Allura X-per tables have 'feather-light' free-floating table tops. They combine single-finger push-to-pivot movement and effective store/recall positioning with excellent stability for CFR and easy patient transfer thanks to the lower height adjustment. The cradle and tilt options further enhance visualization for gravity-oriented or puncture procedures, while keeping the region of interest centered in the X-ray beam. Our AlluraClarity system can be seamlessly integrated with the INAQUEST MAGNUS CR table as well. (See page 1)

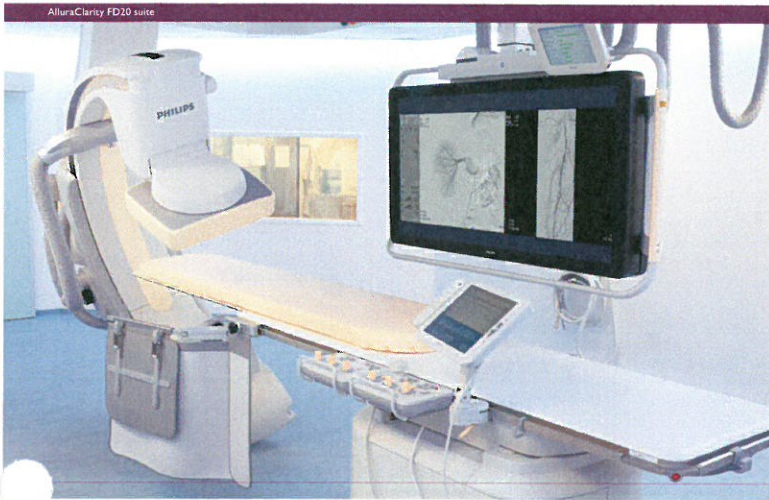

AlluraClarity FD20 suite

AlluraClarity FD20/20 suite

With true full 2k (2,048 x 2,048) imaging for increased quality, the AlluraClarity FD20 supports a full range of cardiovascular, radiology, and oncology interventions. A true multi-purpose system, it accepts a broad range of integrated 2D and 3D software tools.

The AlluraClarity FD20/20 biplane neuro and vascular X-ray system offers exceptional insight for challenging diagnostic examinations and neurovascular interventions. It features two large flat detectors with Philips 2k imaging, as well as advanced interventional tools, so you get superb view of vessel morphology.

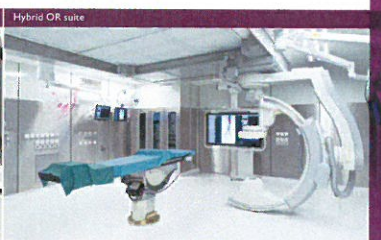
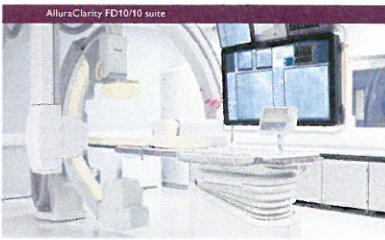

AlluraClarity FD10/10 suite

AlluraClarity FD10 suite

AlluraClarity FD20/10 suite

Hybrid OR suite

The AlluraClarity FD10/10 allow you the flexibility and quality required to treat congenital heart disease and carry out complex electrophysiology procedures. Dedicated ClarityIQ EPX dose settings help you achieve low radiation dose and the excellent image contrast to visualize low inherent tissue contrast or tissue density of patients.

The AlluraClarity FD10 is ideal for your complex PCI, structural heart and electrophysiology procedures. You gain valuable insight and efficiency through a wide array of advanced interventional tools. Our unique C-shaped stand increases speed and provides excellent patient access. It allows you to reach the groin without repositioning, facilitates a wide range of projections, and provides full body coverage. It can also be parked out of the way to further free up patient access.

Get excellent view for the full spectrum of cardiac, vascular, and neurovascular interventions with the Philips AlluraClarity FD20/10 biplane X-ray system. It combines the stable geometry of the AlluraClarity family with our superb flat detector image quality to give you superb view of vessel morphology. This system can be beneficial when treating elderly and renal insufficiency patients. A full range of advanced interventional tools provide advanced image guidance to support decision making.

The AlluraClarity family R is designed for your hybrid surgery lab, combining the capabilities of an endovascular suite with all the requirements of the OR environment. You'll find superb patient accessibility and full body coverage for procedures like TAVR and EVAR, combined with the flexibility to easily convert from an endovascular to an open surgery procedure.

# FlexMove: get more out of your Hybrid suite

With the shift away from open surgical procedures towards minimally-invasive surgery, the Hybrid OR must accommodate the broadest range of procedures. Our solutions allow you to perform a full range, from endovascular and hybrid to minimally-invasive or open surgery. All in a single room. Your entire medical team can work smoothly together and quickly adapt the room to the different set-ups required for diverse procedures. All in all, our Hybrid OR with advanced Live Image Guidance can help you break new ground in hybrid procedures and make the difference where it really matters – at the point of patient treatment.

## Key advantages

- Increase utilization by performing a wide range of procedures in one room
- Hybrid procedures can reduce the number of separate procedures required for a patient
- New treatment options have the potential to enhance patient care and shorten overall patient recovery times, which may reduce the overall cost of treatment

“We are delighted with the way the FlexMove ceiling suspension allows you to bring the imaging system to the table, the way you can park it away from the table, the way you can rotate it, and the way you can bring it to exactly the position you want.”

Prof. Mario L. Lichar MD

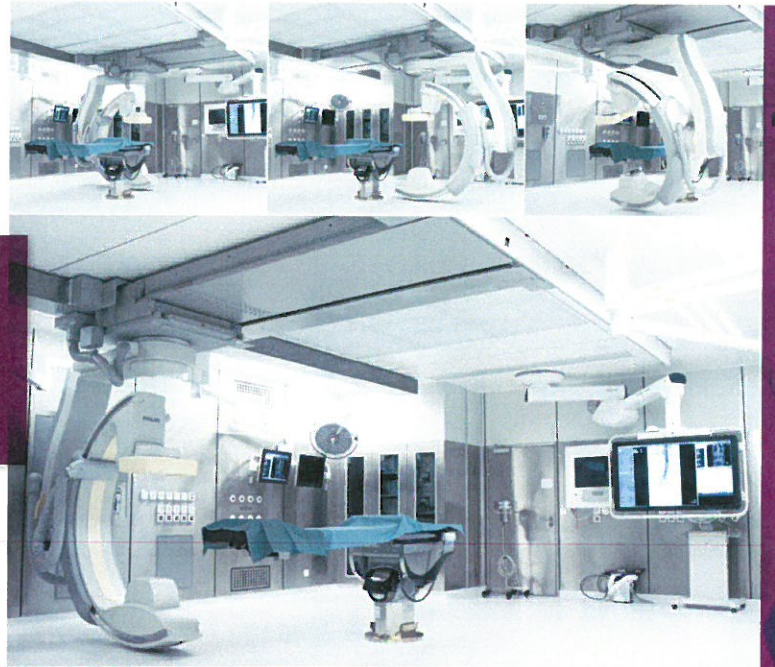

Add value with a people-focused environment



Transform your interventional environment with Ambient Experience. This customized solution integrates Philips expertise in architecture, design, lighting and technology to create a more positive experience for patients and hospital staff. Improvements in workflow, patient compliance and emotional well-being are tangible results.

See critical details

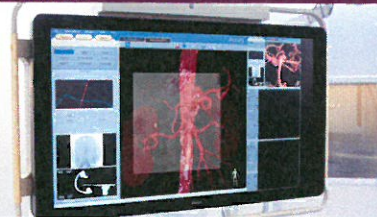

The FlexVision XL 56-inch high-definition monitor provides for personal settings so you can view critical data how you want to see it. Create procedure-specific layouts according to your preferences. Switch your image source, position, and size on the fly or use one of 24 predefined screen layouts. SuperZoom enlarges small details at full resolution.

Personalize your procedures



Philips AlluraClarity family builds on our long experience in personalization to put you in control and reduce manual tasks. Your personal preferences and protocols are pre-programmed, saving time and effort. Everything from patient data management, exams scheduling, image acquisition, system movement, image post-processing and archiving can be set to match each individual clinician's preferred way of working.

Control exams more easily



Our touchscreen tableside module is very easy and intuitive to use. Settings can be customized per doctor or exam so that only the required buttons and items are displayed. You can easily control all interventional tools and other third party devices from the tableside. And the modules can be installed on any side of the table, including at its foot-end.



Clinical support within reach



#### Clinical support within reach

Easily access the information you need to make informed decisions and work with precision and certainty:

- View multi-modality images and information from your PACS and other medical devices, such as fractional flow Reserve (FFR) measurements and ECG signals, on the examination and control room monitors.
- Control third-party devices tableside, such as EP recording, ultrasound imaging and iodine injectors.
- Move the MAQUET MAGNUS OR table in sync with the Philips AlluraClarity X-ray system to streamline procedures.

#### Enhancing patient care through robotics

We believe that robotic-assisted interventional technologies have the potential to help physicians enhance patient care through higher precision and better reach, while creating a comfortable working environment. We are exploring the most promising initiatives from and by partnering with various innovators in the medical robotics field.

## Access patient data effortlessly

#### Xper Flex Cardio

Philips Xper Flex Cardio is a compact physio-monitoring system that fits easily on an X-ray table or cart. It provides relevant information without getting in the way, supporting fractional flow reserve measurements, and provides advanced ECG analysis tools - including culprit artery detection and ST maps - thanks to its DXL algorithm.

#### Hemodynamic documentation

Xper IM captures and integrates cath lab data at the point of care, which gives you comprehensive hemodynamic monitoring and analysis. It also helps simplify the cath lab workflow by reducing the need for manual data entry, decreasing errors and enhancing data integrity.

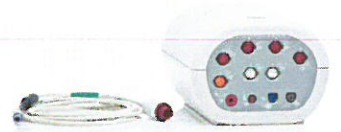



## Extend the reach of your interventional practice

Helping you develop and motivate a best-in-class staff

Our comprehensive clinical, technical and education programs are designed to help you take full advantage of our Live Image Guidance solutions. They make it easy for you to learn complex topics, while contributing to your personal development and performance.

Through our training helps you to master clinical procedures, get more out of the equipment and build professional and clinical skills. This has a number of advantages. Better-trained staff increase the overall level of service and operation in a healthcare facility. More knowledgeable personnel have a higher chance of obtaining accurate results and helping to meet regulatory requirements. These are all tangible ways to help reduce your business risk.

We have education programs for all kinds of healthcare professionals, ranging from nurses and radiologists to echographers and physicians. These can take place at a Philips Healthcare Academy campus, on-site at your healthcare facility by a Philips specialist, or through a combination of the two. Philips also offers customized training courses at the Center for Advanced Medical Learning and Simulation (CAMLMS). In addition, it's possible to receive training wherever and whenever it suits you through our on-line Learning Center.

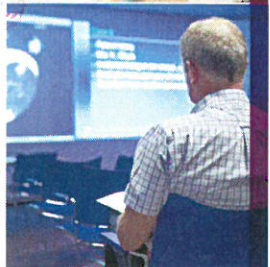
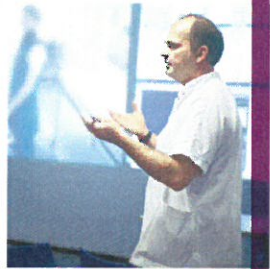



## Increased Economic Value

### Our commitment to you

We are dedicated to helping you keep the quality of care as high as possible - and your costs and risks as low as possible.

When your healthcare facility purchases a new interventional suite you are making a long-term commitment to your patients and personnel. We too have a long-term vision for interventional imaging, supported by an extremely comprehensive portfolio of service options.

### Enjoy new control and confidence in your integrated environment

Whatever your needs or preferred partners, we can help you design an interventional room that meets your critical needs. Our comprehensive design and project teams have designed thousands of interventional rooms and hybrid ORs around the globe, and they can simplify the entire process from initial idea to realization. Based on your procedures, case load and clinical workflow, we work closely with our alliance partners and other third-party vendors to create an integrated design. It can incorporate lights, equipment booms, monitors, radiation protection, other imaging systems, gas, IT and any other specific equipment required.

### Philips and Georgia Regents reshaping Healthcare

Georgia Regents Medical Center (GRMC), Augusta Georgia, and Philips entered into a 15-year, \$300 million agreement to improve outcomes and deliver more effective and cost-effective care to the four to six million people being served. Thought-leaders at GRMC turned to Philips to help them "build a new reality" where manufacturer and hospital work together in planning, design, workflow, decision support, and services, to deliver high quality care throughout the entire health system.

"By collaborating with Philips, we're bringing all the stakeholders together at the same table to better assess and plan health care for tomorrow. It's no longer a simple supply-and-demand business model. Our goal is to foster an atmosphere of meaningful innovation that will have a significant and positive impact on the health of our patients."

David S. Herber, Chief Executive Officer, Georgia Regents Medical Center

Making the difference with Philips for Image Guidance | Philips AlluraClarity family 29



### Supporting your vision

Whether you want to reduce your operational risk and equipment downtime, leverage your in-house service capabilities or use your system more effectively, you simply choose the support that is the right fit for you. Our flexible portfolio offers coverage – from premium service plans to an à la carte solution for customers with in-house engineering teams – that aligns with your budget and internal resources. We can also tailor a service offer as requested. And of course, as your needs change, our support is flexible enough to change with you.

We offer the core services listed below – and more – individually, as part of a RightFit Service Agreement\*, other service agreements or other managed services program:

- Maintenance Services – remote and on-site services, proactive monitoring and multi-vendor services
- Education – applications education, continuing clinical education and technical service education
- Consulting – performance improvement, project and change management, utilization and process optimization
- Ambient Experience – room solutions and design consulting
- Finance Solutions – custom financing for technology acquisition
- Turn-Key Solutions – from room design to complete project management and integration with all internal and external parties
- Product Lifecycle Solutions – through updates, upgrades, accessories, trade-in options and refurbishing programs; you always have easy access to the latest innovations throughout the lifecycle of your lab.

### Manage your investment

Philips SmartPath is our long-term promise to give you easy access to the latest innovations throughout the lifecycle of your imaging system.

- Enhance: software and hardware updates to help increase your system performance.
- Enhance: new functionality, clinical innovations and workflow efficiencies to expand your capabilities.
- Transform: conversion or full replacement of existing systems to next-generation solutions helps you maintain your competitive edge and high quality of patient care.

### Sustainability

Making your business more sustainable is not only about recognizing the needs of future generations. It leads to a safer environment, increased workflow, lower costs and state-of-the-art patient- and people-focused solutions. At Philips, we try to simplify healthcare by combining our unique clinical expertise with human insights. This allows us to develop innovations that ultimately help increase the quality of people's lives. At the same time, we strive to deliver sustainable healthcare by providing solutions that help you make the best use of your resources, from people and buildings to financial and natural resources.

The AlluraClarity family fits perfectly in our Green Product line. With our Live Image Guidance solutions, we help shorten procedure times, which adds value from an economic, environmental and social perspective for your patients and organization. Our SmartPath program is another perfect example how we focus on enhancing the lifecycle of our products and thus reducing environmental impact and increasing your investment while giving you access to excellent technology.

\*The RightFit Service Agreements portfolio is not yet available in all countries.



### References

#### Treating Cardiac diseases (pages 11-13)

- Transcatheter Aortic Valve Implantation in the Hybrid Catheterisation Laboratory – Navigating into the Future, Michael Lauterbach et al, *Interventional Cardiology: Interventional Cardiology*, 2012;7(1):53–8
1. Knecht S, et al. Computed tomography-fluoroscopy overlay evaluation during catheter ablation of left atrial arrhythmia. *Europace*, 2008; 10: 933-8.
  2. Knecht S, et al. Prospective randomized comparison between the conventional electroanatomical system and three-dimensional rotational angiography during catheter ablation for atrial fibrillation. *Heart Rhythm*, 2010; 7: 459-465.
  3. Stevenhagen et al., Three dimensional CT overlay in comparison to CARTO-MERGE for pulmonary vein anatomy isolation, *JCE* Jan 2010.
  4. Teh et al., "Short-Angle Rotational Angiography Allows Accurate Visualization of LA-PV Anatomy and Improves Workflow for AF Ablation." (accepted for *Heart Rhythm* 2013, Denver USA)
  5. Stevenhagen et al., Three dimensional CT overlay in comparison to CARTO-MERGE for pulmonary vein anatomy isolation, *JCE* Jan 2010.

#### Treating vascular diseases (pages 14-16)

1. Three-Dimensional Rotational Angiography of the Foot in Critical Limb Ischemia: A New Dimension in Revascularization Strategy? et al., *CVIR* 2012, (doi:10.1007/s00270-012-0541-7)
2. "The detection accuracy of XperCT for HCC lesions non-visible with standard 2D angiography is 96.7%" Miyayama et al., *CVIR* 2009
3. "When compared to the gold standard bi-phasic CE-MRI, the detection accuracy of XperCT for HCC lesions is 94% when two phases are acquired." Colliro et al., *CVIR* 2011
4. "TACE guidance software using CBCT technology has a sufficient performance level to detect small HCCs and their feeding branches." Miyayama et al., *JVR* 2013



© 2014 Koninklijke Philips N.V. (Royal Philips).  
All rights are reserved.

Philips Healthcare reserves the right to make changes in specifications and/or to discontinue any product at any time without notice or obligation and will not be liable for any consequences resulting from the use of this publication.

Printed in The Netherlands.  
Document order number: 4522 962 98811 \* MAR 2014

How to reach us  
[www.philips.us/healthcare](http://www.philips.us/healthcare)  
[healthcare@philips.com](mailto:healthcare@philips.com)

Product information  
[www.philips.us/AlluraClarity](http://www.philips.us/AlluraClarity)



# Advanced interventions in your lab

Philips Allura Xper FD20 system specifications

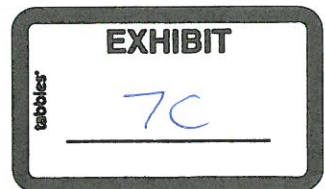

**PHILIPS**  
sense and simplicity

*The print quality of this copy is not an accurate representation of the original.*

# Contents

	<b>Introduction</b>	<b>3</b>	<b>6</b>	<b>Additional options</b>	<b>18</b>
<b>1</b>	<b>Geometry</b>	<b>4</b>	6.1	Subtracted Bolus Chase	18
1.1	Gantry	4	6.2	2D Quantification packages	18
1.2	Patient support	5	6.3	XperSwing	19
1.3	Monitor Ceiling Suspension	6	6.4	Rotational scan	19
1.4	Accessories	6	6.5	CX50	19
<b>2</b>	<b>User Interface</b>	<b>7</b>	<b>7</b>	<b>Interventional tools</b>	<b>20</b>
2.1	Xper User Interface in the examination room	7	7.1	Allura 3D-RA	20
2.2	Xper User Interface in the control room	8	7.2	Dynamic 3D Roadmap	20
2.3	User Interface options	10	7.3	XperCT	20
<b>3</b>	<b>X-ray generation</b>	<b>11</b>	7.4	XperGuide	21
3.1	X-ray generator	11	7.5	Allura 3D-CA	21
3.2	X-ray tube	11	7.6	StentBoost	21
3.3	SpectraBeam	12	7.7	CT TrueView	21
3.4	X-ray indication	12	7.8	EP navigator	22
3.5	DoseWise	13	7.9	EP cockpit	22
3.6	DoseAware	13	7.10	ECG triggering	22
<b>4</b>	<b>Imaging</b>	<b>14</b>	<b>8</b>	<b>Integration solutions</b>	<b>23</b>
4.1	Dynamic Flat Detector	14	<b>9</b>	<b>Services</b>	<b>25</b>
4.2	Fluoroscopy	14	<b>10</b>	<b>Room layout</b>	<b>26</b>
4.3	Digital acquisition	15			
<b>5</b>	<b>Viewing</b>	<b>16</b>			
5.1	Monitors	16			

# Introduction

Today, new interventional treatments and applications are constantly being pioneered. And although this expansion is exciting, it means that you must be more versatile than ever before. You must be equipped with an X-ray system that is capable of performing an increasingly wide variety of complex procedures.

The Allura Xper FD20 is perfectly suited to your changing needs... in fact, it is everything your interventional department needs today and tomorrow.

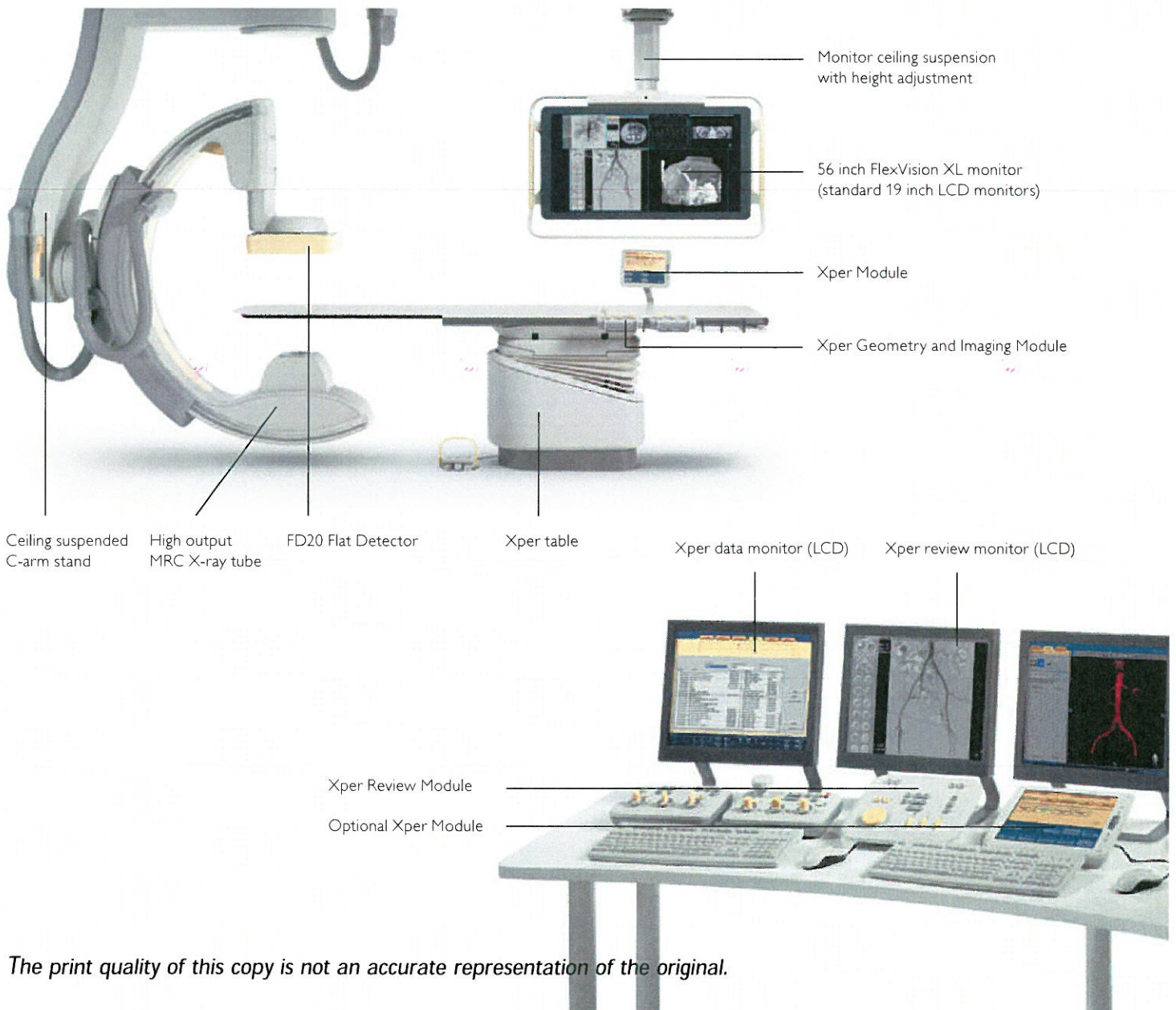

*The print quality of this copy is not an accurate representation of the original.*

# 1 Geometry

## 1.1 Gantry

Rock stable gantry design with fast and easy table side controlled operation, with full flexibility in applications by free positioning of the gantry, monitor suspension and operating modules.

The exclusive BodyGuard patient protection mechanism is designed to protect the patient from unexpected contact between the detector and the body. It uses capacitive sensing to determine patient location to help prevent collision, while allowing stand positioning at up to 25°/sec.



Allura Xper FD20 ceiling stand with motorized L-arm and C-arm



Allura Xper FD20 floor stand with motorized L-arm and C-arm

Features	Specifications
Iso-center to floor	FD20 ceiling: 106.5 cm (41.9 inch) FD20 floor: 113.5 cm (44.7 inch)
Longitudinal movement	FD20 ceiling is manual and motorized of 300 cm (118.1 inch) at 15 cm/sec. It includes auto stops at the park position, cardio position, neuro position and lower peripheral position FD20 floor has no longitudinal movement
L-arm rotation	Motorized and manual movement, over 180° with snap positions at 90°, -0°, -90° to allow patient access from three sides of the table
C-arm rotation	In head-end position: 120° LAO, 185° RAO, in side position: 90° LAO, 90° RAO
C-arm rotation speed	Up to 25°/sec. and 55°/sec. for rotational scan
C-arm angulation	In head-end position: 90° cranial, 90° caudal. In side position: 185° cranial, 120° caudal
C-arm angulation speed	Up to 25°/sec.
Focal spot to iso-center	81 cm (31.9 inch)
Source Image Distance	89.5 to 119.5 cm (35.2 to 47.1 inch)
C-arm depth	90 cm (35.4 inch)
Rotation of the flat detector	Xper Access allows re-positioning of the Flat Detector from portrait to landscape within three sec.
Programmable positions	Standard two positions

## Optional

### Automatic Position Controller (APC)

Functionality for the stand is accessed through the Xper Module at the patient tableside.

- This option includes a programmable position extension, which allows you up to ten different stand positions per clinical procedure.
- Another feature of the APC is reference-driven positioning. This allows you to recall stand positions by referring to the images at the reference monitors, which means that the rotation, angulation, SID, and detector orientation are restored to the original settings of the reference image.

## 1.2 Patient support

The Xper table offers full range of applications, without restriction on position during CPR. The Xper table is a dedicated interventional X-ray table with a free-floating tabletop. This table has very high patient loadability and can make large floating movements.



Xper table cradle

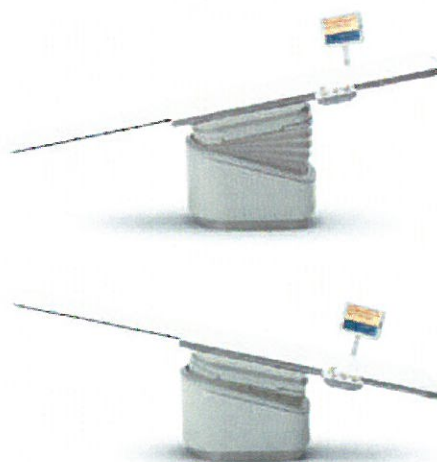

Xper table tilt

Features	Specifications
Tabletop material	Radio translucent carbon fiber tabletop
Tabletop length	319 cm (125.6 inch)
Tabletop width	50 cm (19.7 inch)
Motorized tabletop height adjustment	79 to 107 cm (31.1 to 42.1 inch)
Tabletop metal free overhang	125 cm (49.2 inch)
Longitudinal float	120 cm (47.2 inch)
Transversal float	36 cm (14.2 inch)
Maximum allowable patient weight	250 kg with additional force of 500 N, allowed in case of CPR. CPR can be performed while the tabletop is set in any longitudinal position
The positioning of the modules	The Xper Module, Xper Imaging, and Xper Geometry Modules can be positioned on three sides of the patient support
Cable integration	Cables are incorporated in the table to allow maximum operation flexibility
Patient mattress	The mattress is made of slow recovery foam, with a density of 58 kg/m <sup>3</sup> and a thickness of seven cm that adapts to the patient body shape.

## Optional

Table tilt	Yes, Xper table tilt; tilt range: 17° head-down to 17° head-up; tilt speed: 2°/sec.
Iso centric tilt movement	Yes
Cradle movement	Movement: yes, with Xper Cradle; range: -15° to +15°; speed: 3°/sec.
Iso centric cradle	Yes
Pivot range	-90° to +180° (or -180 to +90°). Table can be locked at any position and indents at 0, -13° and +13° (to support arm angiography).
Table Swivel	78.2 cm longitudinal motorized
Table Automatic Position Controller	It contains store and recall functionality of the height-, longitudinal- and lateral position of the table top. This allows returning to a previously stored position, without using X-ray dose.
Operating tables	The Allura Xper FD OR table systems can be combined with a compatible operating table instead of the Xper table. For the table specifications please refer to the operating table manufacturer documents.

### 1.3 Monitor Ceiling Suspension

The Monitor Ceiling Suspension allows flexible, freely rotating positioning with a concave set-up of the monitors for optimal viewing angle.

Feature	Specifications
Number of monitors	Two, three, four, six or eight monitors
Rotation range	350°
Transversal movement	Over a distance of 300 cm (118.1 inch)
Longitudinal movement	Over a distance of 330 cm (129.9 inch)

### 1.4 Accessories

#### 1.4.1 Standard accessories

- Mattress
- Neuro Mattress (if Neuro tabletop)
- Patient straps
- Set of arm supports (if cradle)
- Dripstand
- OP rail accessory clamps
- Cerebral filter
- Cable holders (15 pieces)



Mattress (standard delivery of one piece per table)

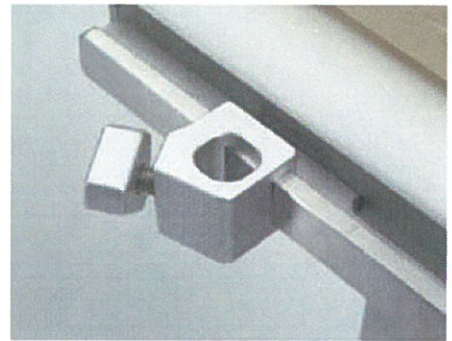

OP rail accessory clamps

## Optional

#### 1.4.2 Optional accessories

- Arm support (height adjustable)
- Ratchet compressor
- Table X-ray protection
- Peripheral X-ray filter
- Pulse cath arm support
- Examination light
- MCS bracket ceiling rad. shield
- Ceiling suspended radiation shield
- Panhandle
- Longer Mattress
- Head support
- Arm support, incl. mattress pad
- Table clamp
- Set handgrips and clamps
- Neuro wedge
- Additional op-rail
- Additional op-rail (USA version)
- Additional op-rail with cable extension kit for Xper Modules

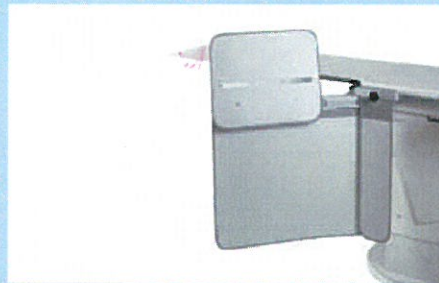
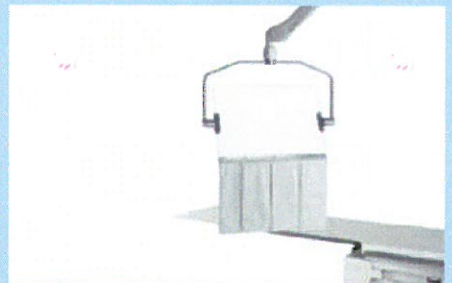

Table X-ray protection



Ceiling suspended radiation shield



Panhandle



Head support



## 2 User Interface

Tailor made customized operating user interface per user (groups) and per desired application is available. Full integration of the complete system user interface is available at table side. Xper stands for "X-ray Personalized", and reflects the expert nature of the Allura Xper FD20 system.

### 2.1 Xper User Interface in the examination room

In the examination room, the Xper User Interface comprises the On-Screen Display, the Xper Module, and the Xper Imaging and Geometry Modules. Information displayed on the On-Screen display in the examination room.

The Xper Geometry and Imaging Module can be positioned on three sides of the patient table. The Modules adjust to the position to retain the intuitive button operation. Both the Xper Geometry and Imaging Module have a removable protection bar that prevents unintended activation of system.

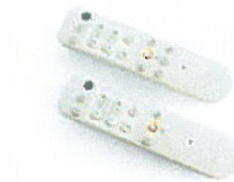

Xper Viewpad controls



Xper Geometry Module



Xper Module



Xper Imaging Module

#### Xper User Interface

- X-ray indicator
- X-ray tube temperature condition
- Radiographic parameters: kV, mA, ms
- Rotation and angulation of the stand positions
- Source Image Distance (SID)
- Table height
- Detector field size display
- General system messages
- Selected frame speed
- Fluoroscopy mode
- Integrated fluoroscopy time
- Air Kerma X-ray dose (both rate and accumulated X-ray dose)
- Dose Area Product (both rate and accumulated X-ray dose)
- Graphical bars for body zone specific X-ray dose rate and accumulated Air Kerma levels related to the 2Gy level for cardiac procedures
- Stopwatch

#### Xper Viewpad controls

- Run and image selection
- Exam and run cycle
- Review speed
- Run and exam overview
- Active exam sub files (exposure image/runs, reference images, print file)
- Flagging exam and run for storage
- Digital zoom
- Storing reference run or image to reference monitors
- Select reference monitors for review and/or processing of previous run exposures
- Subtraction and image mask selection

#### Xper Module

- Acquisition setting
- Image Processing
- USB port for data transfer
- Automatic Position Control (APC), optional
- Quantitative Analysis (QA), optional
- Table Automatic Position Controller, optional
- Interventional tools, optional
- ViewForum and Xcelera software, optional
- Hemo on Xper Module, optional

### Xper Geometry Module

Tabletop float  
Table height position  
Table tilt angle (if the tilt option is selected)  
Table cradle angle (if the cradle option is selected)  
Source Image Distance (SID) selection  
Flat Detector portrait/landscape position  
Stand positioning  
Longitudinal movement of the stand along the ceiling  
Stand rotation in an axis perpendicular to the ceiling  
Store and recall of two scratch stand positions including SID and detector orientation  
Emergency stop button  
Accept button of the Automatic Positioning Control  
Geometry reset button, which resets stand and table to a default service configureable starting position

### Xper Imaging Module

Fluoroscopy mode selection as defined via Xper settings  
Positioning of shutters and wedges without radiation  
Manual or automatic wedge including position on the last image without radiation  
Xper fluoro storage to record up to the last 20 seconds of fluoroscopy  
Selection of the detector field size  
Preferred beam width  
Reset of the fluoroscopy buzzer  
Selection of trace subtract fluoro function  
Selection of SmartMask function, optional

## 2.2 Xper User Interface in the control room

The Xper Viewing console comprises a 19 inch LCD color data monitor for patient data and system information management, including radiographic parameters, and a 18 inch black and white review monitor and Review Module enabling efficient exam viewing and post-processing. The monitors have shared screens.

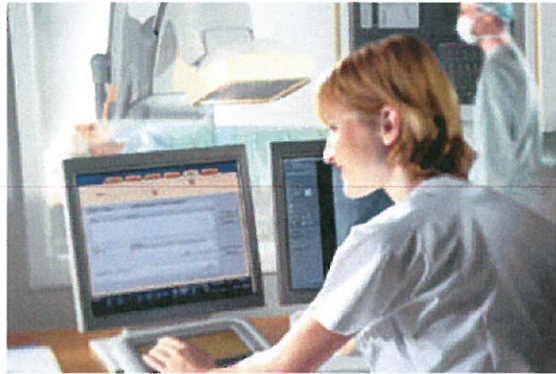

### Xper data monitor

Scheduling  
Preparation  
Acquisition  
Review  
Report  
Archive

### System information

Stopwatch and time  
System guidance information  
Dose Area Product (DAP) and Air Kerma X-ray dose (both rate and accumulated X-ray dose)  
Frame speed settings, fluoroscopy mode and accumulated fluoroscopy time  
Exposure and fluoroscopy settings, such as Voltage (kV), Current (mA) and pulse time (ms)  
Stand position information, such as rotation, angulation and SID

#### Xper review monitor

The Xper review monitor is a 18 inch black and white LCD monitor that shares a screen with the color data monitor.



#### Xper Review Module

The Xper Review Module is a review station for basic interventional X-ray viewing needs. The most often used functions can be controlled by the touch of a button.



#### Xper review monitor

- Step through file, run or images
- File and run overview
- Image processing features such as contrast, brightness and edge enhancement
- Flagging of runs or images for transfer
- Image annotation
- Automatic printing
- Subtraction
- Move or renew mask
- Landmarking (increase/decrease of subtraction degree)
- Video invert
- Zoom and pan image
- View trace
- Pixel shift
- Electronic shutters
- Toggle switch physio
- Store/delete images/runs
- Store fluoro
- Quantitative Analysis Packages, optional

#### Xper Review Module

- Power on/off of the system
- Tagarno wheel to control the review of a patient exam
- File and run cycle
- Adjustment of contrast, brightness, and edge enhancement
- File, run, and image stepping
- Run and file overview
- Basic review functionality, such as image invert and digital zoom
- Go to default settings
- Reset fluoroscopy timer and switch X-ray on/off

## Optional

### 2.3 User Interface options

#### Second or third Xper Module

The Allura Xper FD20 can be extended with additional Xper Modules. The functionality of these Xper Modules is equivalent to the functionality on the Xper Module connected in the examination room.

#### Xper Pedestal

The Xper Pedestal creates an additional flexible workspot for operating the system in the examination room. The pedestal is equipped with additional Xper Geometry and Imaging Modules and can also hold the X-ray footswitch. Optionally, an additional Xper Module can be mounted on the pedestal. The Xper Pedestal can be positioned freely around the patient table and can be stowed away when not in use.

#### Second Xper Imaging Module

Extension of the imaging controls with a second module in the control room in a master-slave configuration.

#### Second Xper Geometry Module

Extension of the geometry controls with a second module in the control room in a master-slave configuration.

#### Contrast Injectors

The system is optimized for coupling with several contrast injectors.



Second or third Xper Module



Xper Pedestal

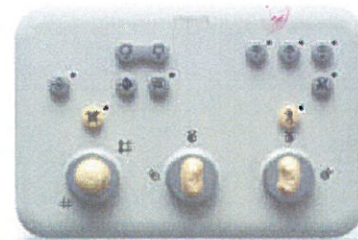

Second Xper Imaging Module



Second Xper Geometry Module

# 3 X-ray generation

## 3.1 X-ray generator

The Velara generator is optimized for the latest interventional X-ray needs.

Features	Specifications
Generated power	Microprocessor-controlled, 100 kW high frequency converter generator
Minimum switching time	Quartz-controlled power-switch, with a minimum switching time of one ms
Voltage range	40 to 125 kV
Maximum current	1250 mA at 80 kV
Maximum continuous power	2.4 kW for 0.5 hours, 2 kW for eight hours
Nominal power (highest electrical power)	100 kW (1000 mA at 100 kV)

With Xper settings on the Xper Module, different exposure protocols can be customized for every clinical application.

## 3.2 X-ray tube

The Allura Xper FD20 is provided with the legendary high power MRC-GS 0407 X-ray tube which allows for very high heat dissipation, enabling SpectraBeam filtration to reduce the patient X-ray dose.

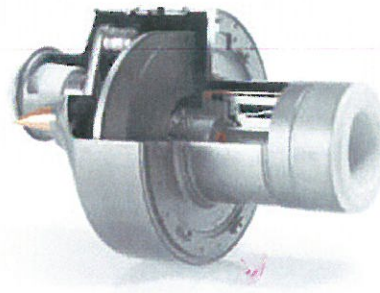

MRC-GS 0407 X-ray tube

Features	Specifications
Focal spot size and loadability	0.4/0.7 nominal focal spot values with maximal 30 respectively 65 kW loadability
Grid-switched pulsed fluoroscopy	Yes
Fluoro power for 10 minutes	4,500 W
Fluoro power for 20 minutes	3,500 W
Anode heat dissipation	11,000 W
Max. heat dissipation of assembly heat	3,400 W
Extra pre-filtration	SpectraBeam dose management with 0.2, 0.5, and 1.0 mm Copper equivalent SpectraBeam filters
Cooling liquid	Oil cooled X-ray tube with thermal safety switch
Anode cooling method	Direct anode oil cooling system with 200 mm anode diameter

### 3.3 SpectraBeam

The combination of SpectraBeam with the MRC-GS 0407 tube allows increased X-ray output with better filtration of soft radiation. This reduces patient X-ray dose for cardio and vascular applications, while maintaining the same excellent image quality.

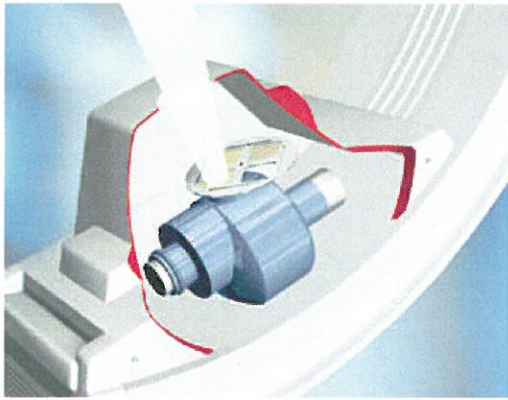

SpectraBeam with unique beam filtration

#### Xper Beam Shaping

Xper Beam Shaping allows for virtual collimation of the shutters and wedges on the last X-ray image, eliminating additional X-ray dose during collimation changes.

#### Double wedge filters

Double wedge filters provide outstanding image quality in all projections. The wedge filters allow exceptional exposure and hence excellent image quality is maintained (with minimal patient entrance X-ray dose).

#### Anatomical filters

Filters designed to compensate for large absorption differences in the object. There are special filters for cerebral angiography and the optional lower peripheral angiography.

#### Automatic wedge positioning

Wedge filters can be positioned automatically according to gantry positions.

### 3.4 X-ray indication

#### "X-ray On" indicator light

The Allura Xper FD20 has an integrated "X-ray On" indicator light located above the LCD monitors that is clearly visible from virtually anywhere in the room.

#### Real-time X-ray dose information at tableside

Relevant dose information is integrated in the On-Screen User Interface of the LCD exam room monitors of the Allura Xper FD20 system. It provides the user with all relevant dose information, including accumulated and rate values of patient Air Kerma and X-ray dose area product. In addition, body zone specific X-ray dose rates are displayed for cardiac procedures. X-ray dose rates can be controlled by the user at tableside, by choosing a different fluoro mode.

#### X-ray dose information in the control room

X-ray dose information is also available in the control room. Cumulative dose is displayed on the Xper data monitor.

#### X-ray dose information in the examination report

Examination report data can be provided via the RIS/CIS DICOM two-way interface, to the RIS/CIS (MPPS protocol). A X-ray dose report can optionally be printed or e-mailed (in background) at the end of each examination at the touch of a button. Body zone specific information is included.

#### Specifications

Copper filters: 0.2, 0.5, and 1.0 mm copper equivalent  
The filters can be programmed via Xper settings  
Three fluoroscopy modes per application can be selected at tableside

### 3.5 DoseWise

DoseWise is a set of techniques, programs, and practices that ensures excellent image quality, while protecting people in X-ray environments. It's a philosophy that drives Philips to develop innovative new strategies in dose management. DoseWise focuses on three highly effective strategies for dose management:

- **Smart Beam management:** use the exact amount of X-ray dose needed per examination.
- **Less radiation-on time:** choose very low pulse frequencies with major X-ray dose savings, while ensuring diagnostically relevant images.
- **More Awareness:** simple, easy to read displays and reporting - keeping you aware of dose levels, and fully in control.



Staff working in an X-ray environment wears a Personal Dose Meter (PDM).

### 3.6 DoseAware

The ability to see your dose exposure in real-time is now possible thanks to Philips DoseAware. An innovative new product that will transform the way you work. Only Philips DoseAware visualizes the invisible nature of radiation so clinicians and staff can see it in real time through a simple and easy to read display and immediately act to change their behavior and work patterns.

Staff working in an X-ray environment wears a Personal Dose Meter (PDM). This PDM measures X-ray dose reception and is wirelessly connected to the Base Station. The Base Station is mounted in the examination room where all staff can directly see whether received dose is in the red, yellow or green area. X-ray dose history information can be automatically retrieved from any Base Station or from any PDM by using a Cradle with DoseView software of Dose Manager software. Working dose conscious is working healthier.



The BaseStation, a LCD touchscreen displays real time dose data for all PDMs within range, to enable you and your staff to take immediate action.

# 4 Imaging

The Allura Xper FD20 is equipped with a compact dynamic flat detector which can easily handle complex projections. Image quality and X-ray dose reduction are further enhanced by dedicated image processing.

## 4.1 Dynamic Flat Detector

Philips' next generation Dynamic Flat Detector provides excellent image quality at a low patient X-ray dose.

Features	Specifications
Size of detector housing	42 x 52 cm (16.5 x 20.5 inch), including BodyGuard
Maximum field of view	30 x 38 cm (11.8 x 14.9 inch)
Image matrix	2480 x 1920 pixels at 14 bits depth
Detector zoom fields	30 x 30 cm (11.8 x 11.8 inch), 26 x 26 cm (10.2 x 10.2 inch), 22 x 22 cm (8.7 x 8.7 inch), 19 x 19 cm (7.5 x 7.5 inch), 16 x 16 cm (6.3 x 6.3 inch), 13.5 x 13.5 cm (5.3 x 5.3 inch), 11 x 11 cm (4.3 x 4.3 inch) square formats
Pixel pitch	154 µm
Detector bit depth	14 bits
Nyquist frequency	3.25 lp/mm
DQE (0)	More than 73% at 0 lp/mm
Digital output	2k <sup>2</sup> and 1k <sup>2</sup> and 512 <sup>2</sup> at 14 bit depth resolution
MTF at 1 lp/mm	> 60%

## 4.2 Fluoroscopy

Per application, three fluoro modes are available at tableside which can be programmed via Xper settings. Each mode can be programmed with a different composition of X-ray dose rate, digital processing and filter settings.

Features	Specifications
Extra pre-filtration	SpectraBeam filters: 0.2, 0.5 and 1.0 mm Copper equivalent
Fluoroscopy image processing	Recursive filtering, localized contrast-adaptive contour enhancement, SPIRIT filters and Xres algorithm
Pulse rates	Default at 3.75, 7.5, 15 and 30 pulses per second
Frame grabbing of static fluoroscopy images	Yes
Fluoroscopy storage	Default storage of the last 20 sec. of fluoroscopy for reference or archiving
Grid-switched pulsed fluoroscopy	Yes



### Roadmap Pro

Advanced subtraction angiography techniques are now being used to support highly complex procedures throughout the body. A roadmap is created by superimposing a live fluoro image on an angiographic image. Roadmap Pro is a software tool that provides a flexible range of features to support all anatomical areas and types of interventions. It offers insight into anatomy, and aids interventionalists in carefully positioning tools and materials, evaluating their effect, and deciding how to proceed during a case.

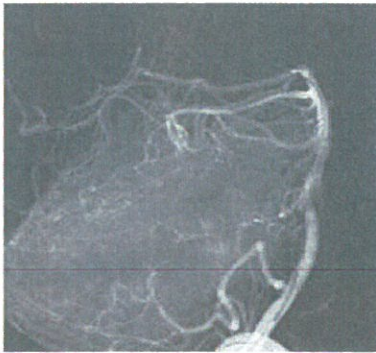

The roadmapping tool tailored for specific clinical applications

### 4.3 Digital acquisition

The Allura Xper FD20 system can be customized with a virtually unlimited number of acquisition programs for digital angiography and digital subtraction angiography. Image resolution is up to 2048 x 2048 pixels for vascular imaging and 1024 x 1024 pixels for interventional X-ray imaging.

#### Acquisition frame rates

	1024 x 1024 matrix	2048 x 2048 matrix
Standard configuration	0,5 to 6 images/sec.	0,5 to 6 images/sec.

Up to 60 images/sec. acquisition at a 512 x 512 matrix is optionally available

#### Storage capacity

	1024 x 1024 matrix	2048 x 2048 matrix
Standard configuration	50,000 images	12,500 images
Storage extension	100,000 images	25,000 images

## Optional

### SmartMask

SmartMask simplifies roadmapping procedures by overlaying fluoroscopy with a selected reference image on the live monitor. The reference and fluoro images can be faded to taste on the monitors.

### Dual Fluoroscopy

The Dual Fluoroscopy mode allows side-by-side display of digitally processed non-subtracted fluoroscopy and trace-subtract fluoroscopy for visualization and catheter guidance during complex procedures.

The dual fluoro option offers live digital zoom capabilities. Images can be zoomed by a factor of two to enlarge the display of the region of interest. With the second reference monitor option, an additional reference image can be displayed next to the two live monitors.

### Cardiac Imaging

Cardiac Imaging comprises of XresCardio and Frame Rate Extension. Xres Cardio is a real-time processing algorithm that provides excellent image quality through improved contrast and sharpness. It exploits the benefits of the fully digital detector to reduce noise in clinical images for cardiac applications. Frame rate extension increases the system acquisition speed for cardiac applications that require high speed imaging. The acquisition speed can be increased to 15fps and 30fps.

# 5 Viewing

## 5.1 Monitors

The system is delivered standard with two black and white 18 inch LCD monitors in the examination room. A 19 inch LCD color monitor and an 18 inch black and white LCD monitor are standard in the control room.



### Monochrome LCD monitor

Features	Specifications
Size of monochrome TFT-LCD display	18 inch monochrome TFT-LCD display
Format	Native format of 1280 x 1024 SXGA
Grey-scale resolution	10 bit with grey-scale correction
Wide viewing angle	Yes (approximately 160°)
High brightness	Yes (max 600 Cd/m <sup>2</sup> , default 500 Cd/m <sup>2</sup> ), with ambient light dependent brightness control
Protection screen	Yes, in the examination room

### Color LCD monitor

Features	Specifications
Size of color TFT-LCD display:	19 inch color TFT-LCD display
Format	Native format 1280 x 1024 SXGA
Wide viewing angle	Yes (approximately 160°)
High brightness	Controlled brightness (200 Cd/m <sup>2</sup> ) with ambient light dependent brightness control
Protection screen	Yes, in the examination room

## Optional

### Second reference monitor

A second reference monitor (monochrome) in the examination room can display both reference images and reference runs. The User Interface on this reference monitor is accessed via the Xper ViewPad. This monitor is also being used for the Dual Fluoroscopy option.



## Optional

### Physio Viewing

Physio Viewing provides acquisition, storage and display of physiological signals on the Allura Xper FD20 system. Four physiological data signals can be acquired and stored. One signal can be displayed when reviewing images.

### MultiSwitch

Xper MultiSwitch enables the Xper workspot in the control room to be shared with other applications that are loaded on separate PC modalities. The MultiSwitch option lets you switch the color LCD data monitor, keyboard and mouse that are normally connected to the Allura Xper system. This saves significant space in the control room by enabling only one monitor and keyboard to be used for multiple optional software applications, like Allura 3D-RA, StentBoost, Allura 3D-CA, XperCT, ViewForum and Xcelera software.

The Xper data monitor can be switched to Radiology/Cardiology Information Systems via the web-based browser (HTML) or X-window (Exceed). It makes full use of the RIS/CIS facilities and existing support for automatic handling of logistic tasks (e.g. automatic tracking, purchasing of supplies and billing) that are available.

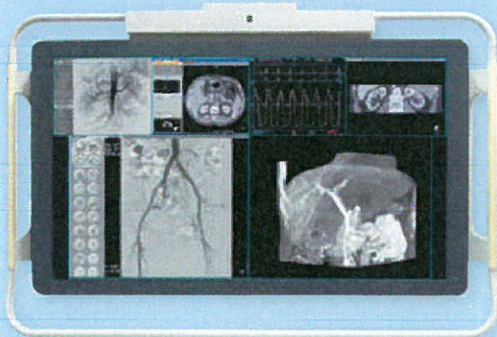

FlexVision XL allows you to display multiple images in variety of layouts

### MultiVision

The MultiVision video switch is the integrated video switch for high quality, progressive display video sources on the color LCD monitor. It can switch either black and white or color signals, and supports up to four inputs to one output. MultiVision enables an extra color monitor in the ceiling suspension in the examination room to be shared between the system and other sources, such as a DICOM viewer, StentBoost, Allura 3D-RA software, etc. The switch is controlled via the Xper Module.

### FlexVision XL

Philips has introduced a new 56 inch display: FlexVision XL. FlexVision XL is a new viewing concept that provides outstanding viewing flexibility, using a large, high-definition LCD screen, it allows you to display multiple images in a variety of layouts - each tailored for your specific procedure.

Xper HD, a standard feature of FlexVision XL, brings High Definition viewing for your clinical images. Sharp and crisp images visualize sub millimeter vessel structures. The full 2k\*2k imaging chain allows using the native resolution of your FD20 Flat Detector to its full potential. This brings you sharp images at full size without zoom.

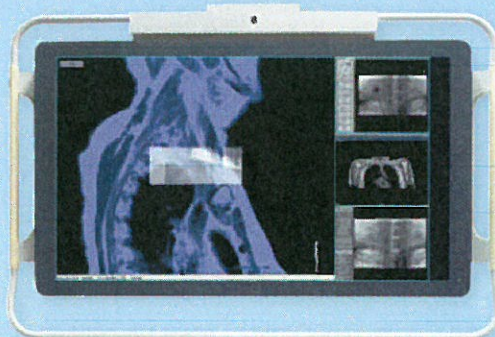

FlexVision XL brings High Definition viewing for your clinical images

# 6 Additional options

## 6.1 Subtracted Bolus Chase

Routine examinations can be performed quickly and confidently with Bolus Chase. A hand-held speed controller is used to constantly match table speed to the speed of the contrast run-off, which is displayed in real-time on the monitor screen. After the contrast run, the recorded speed profile can be used to acquire mask images with the most accurate subtraction results. The result is efficient, accurate run-off studies that may eliminate the need for repeat exposures. Bolus Chase gives fast results for increased patient throughput and improved patient management.

## 6.2 2D Quantification packages

### Quantitative Vascular Analysis (QVA)

QVA is an analytical software package for quantitative analysis. It includes the following functions:

- Calibration routines to enter the scale into the programs (based on the size of the catheter visible in the image).
- Automated Vessel Analysis. This program uses contour detection to calculate vessel dimensions and subsequently analyzes stenoses.
- Vessel diameter and stenotic index. This program measures vessel size and calculates the degree of stenosis.

### Quantitative Coronary Analysis (QCA)

This software package provides quantification of stenosis measurements in the coronary arteries. It includes the following functions:

- Diameter measurement along the selected segment
- Cross sectional area
- Percentage of stenosis
- Pressure gradient values
- Stenotic flow reserve
- Calibration routines

### Left Ventricular (LVA)

The Left Ventricular package quantifies the status of the left ventricle using various relevant data. It includes the following functions:

- Various Left Ventricular volumes
- Ejection Fraction
- Cardiac Output
- Wall Motion (Centerline, Regional, Slager)
- Calibration routines

### Right Ventricular (RVA)

This software package is used to assess ejection fraction and right ventricular volumes. It enables you to perform right ventricular analysis from angiograms. The calculations can be executed from single plane or biplane projections. The package is intended especially for pediatric cardio applications and focuses on easy and efficient wall contour detection. It includes the following functions:

- Calibration routines
- Various Right Ventricular volumes
- Ejection Fraction
- Cardiac output
- Wall Motion (Centerline, Regional, Slager)
- Biplane Ejection Fraction (automatic and manual)

### Full Autocal

The Full Autocal option can be used in conjunction with the quantitative analysis packages. When the object to be analyzed (e.g., Left Ventricle, Vessel Segment) is placed in the iso-center, full autocal avoids the need to:

- Acquire an additional image series containing a sphere or grid for calibration purposes, or
- Calibrate manually on a calibration object (e.g., catheter) displayed in the image or image series to be analyzed.

### CO<sub>2</sub> view trace

This software package enables tracing (stacking) of images acquired with CO<sub>2</sub> injections. This package can be used during post-processing, next to "View Trace" images acquired with iodine injections.

### Measurement (MEAS)

Measurement is an analytical software package for different kinds of measurement, except from stenotic measurements. This option includes angle-, length-, ratio-, and density measurements.

### 6.3 XperSwing

During a dual axis rotation scan, the C-arm operates on two axes simultaneously, enabling it to swing in a three-dimensional arc around the patient, providing a flexibility of movement that allows it to capture the required coronary images in fewer 'runs'. The system rotates with curved trajectories around the patient, thereby allowing imaging in all desired anatomical views in a single run. The trajectories are pre-programmed and are optimized to maximize the clinical image content, while staying within safe boundaries in order to avoid any collisions. Dedicated trajectories are available for the left and the right coronary arteries.

### 6.4 Rotational scan

Rotation image data can be used for advanced post processings, like 3D reconstructions. Rotational Angiography acquires a range of projections to create real-time, 3D impressions of complex 'vascular' and coronary arteries. A contrast run can be followed up with a mask run to allow image/run subtraction. Rotational Angiography can save considerable time and contrast, while providing the image detail required for diagnostic and therapeutic decisions. A rotational scan can be done in both the head and side positions. The high speed acquisition decreases the amount of contrast medium, while the wide rotation range provides a complete evaluation of anatomy.



The CX50 system can be fully integrated into the Allura Xper system via a one-click connection.

### 6.5 CX50

To provide additional support for your interventional procedures, you can extend the power of your Allura Xper system with Philips' unique CX50 ultrasound integration solution. The new CX50 is a compact ultrasound system that enables you to have premium image quality ultrasound available right where you need it, when you need it. The CX50 system can be fully integrated into the Allura Xper system via a one-click connection. The CX50 is controlled at the table side by the Xper module with the ultrasound image displayed on the Allura's ceiling suspended monitor system. In addition, all patient data is shared automatically between the X-ray and ultrasound system eliminating workflow duplication.

Features Rotational Angio		Specifications
C-arm in head position	Maximum rotation speed	55°/sec.
	Maximum rotation angle	305°
C-arm in side position	Maximum rotation speed	30°/sec.
	Maximum rotation angle	180°
Frame speeds		15, 30 and 60 fps.

Users can designate speed, as well as a start and end position, through Xper settings. The clinical images from the rotational scan can be sent automatically to a 3D-RA interventional tool for a reconstruction of static vasculature.

# 7 Interventional tools

In close partnership with our clinical partners, Philips continues to enhance the capabilities of the interventional tools on Allura Xper family. Recent Philips innovations have expanded the clinical utilization by continuous improvement of the acquisition protocols and reduction of reconstruction times and expanding the range of applications with e.g. the guidance on previous acquired high resolution CT and/or MR data sets.

## 7.1 Allura 3D-RA

Allura 3D-RA provides extensive three-dimensional (3D) visualization into vascular pathologies from a single rotational angiographic X-ray acquisition. Paired with the unique whole body coverage of the Allura, which is specifically designed for 3D-imaging, Allura 3D-RA is able to cover any anatomy, including cerebral, abdominal and peripheral vasculature.

The 3D-RA functionality is fully integrated with the Allura system, and can be fully controlled at the table side.

3D-RA volumes can be matched with any previous acquired CT and/or MR scan, enabling improved procedure management for aneurysms, AVMs, stroke or surgical planning.

## 7.2 Dynamic 3D Roadmap

Dynamic 3D Roadmap is based on the visualization of the vessel tree from a 3D-RA, CTA or MRA scan combined with a live 2D fluoroscopy image. Integrated 3D-RA functionality rapidly reconstructs the rotational angiography X-ray run into a 3D volume. A previously

acquired CT angio or MR angio scan can be imported into the system and registered with a low dose 3D-RA scan. The "live" 2D fluoroscopy image is overlaid with the 3D volume of the vessel tree and is automatically displayed on the 3D roadmap monitor in both the examination and control rooms.

The XperGuide functionality is fully integrated with the Allura system, and can be fully controlled at the table side.

## 7.3 XperCT

With XperCT, clinicians can access CT-like imaging right on their interventional system so they can assess soft tissue, bone structures and (intracranial) before, during or after an interventional procedure. XperCT uses acquisition protocols up to 60 frames per second and reconstruction time from 25 to 60 seconds.

XperCT data can also be matched with previous acquired CT and/or MR data sets providing the best of both worlds avoiding additional X-ray and contrast dose for the patient.



Allura 3D-RA: reconstruction to assist decision making for treatment strategy



3D Roadmap: 3D-RA combined with live fluoro with imported CT

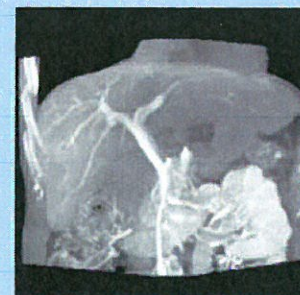

XperCT: liver image after contrast injection

#### 7.4 XperGuide

Philips exclusive XperGuide, provides live 3D guidance by combining real-time fluoroscopy with XperCT, CT or MR soft-tissue imaging in one view for a wide range of clinical procedures from biopsies and drainages to RF ablations.

Virtual needle paths are created on an XperCT dataset or on the original previous acquired CT or MR data. The volumetric dataset and the virtual needle paths can be viewed in any slice orientation. A wide range of gantry projections can be used to define the needle path. Multiple targets can be defined at once and requires no additional navigation or tracking devices to assist in guided procedures.

The XperGuide functionality is fully integrated with the Allura system, and can be fully controlled at the table side.

#### 7.5 Allura 3D-CA

Allura 3D-CA creates a 3D model of 2D coronary artery images. It can help with diagnosis by providing optimal insight into the structure of the coronary tree that leads to improved assessment of lesions and bifurcations. It also gives you insight into the exceptional working angles

Enhance interventional preparation to assist the user to:

- Select the right stent length
- Select view of lesion or bifurcation with "TrueView" map

Enhance interventional execution to assist you/ the physician to:

- Work with optimal viewing angles of lesions and/or bifurcations
- Place the right stent with the right length in the right place

#### 7.6 StentBoost

StentBoost is a simple, quick and cost-effective tool to enhance stent visualization in the coronary arteries. It shows the stent in relation to the lumen of the vessel by contrast overlay – as you are working. This advanced imaging can support you by helping you place the stent accurately the first time, can possibly shorten procedures and potentially eliminate additional ones.

#### 7.7 CT TrueView

CT TrueView connects the Cath lab to the CT room. It provides all the benefits of Allura 3D-CA based on a CT diagnostic image. It offers:

- Optimal C-arc positioning on Philips CT data sets to minimize foreshortening when assessing lesions or bifurcations.
- CTO Navigator provides an overlay of a 2D exposure run over the previous acquired segmented cardiac CT data. The images are matched manually or automatically for images in the same part of the ECG signal.
- Easy to use user interface, on the EBW and interventional tools.

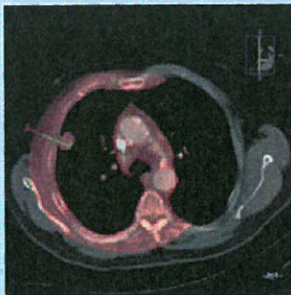

XperGuide: planning on a low dose XperCT, matched with previous acquired CT image

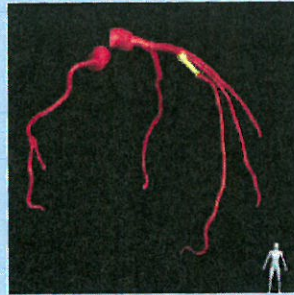

Allura 3D-CA: Create a 3D model of 2D coronary arteries to enhance assessment of lesions and bifurcations



StentBoost: enhance stent visualization in relation to the lumen of the vessel

### 7.8 EP navigator

EP navigator provides a fluoroscopy overlay of a 3D image of the heart, based on either a pre-interventional CT image or an 3D atriography acquisition. EP navigator shows the catheter and the 3D anatomy in real-time in one image, allowing electrophysiologists to instantly confirm the position of any catheter or lead with respect to detailed 3D cardiac anatomy in the EP intervention lab.

### 3D atriography

3D atriography allows the user to create a 3D image of the left atrium on the X-ray system in the EP lab by doing a rotational angiography with contrast injection. An up-to-date view of the cardiac anatomy is vital for guiding EP interventions. Obtaining good CT scans is often difficult, time consuming and expensive, and it requires a high X-ray dose. With 3D atriography, you can create 3D images of the left atrium in your own lab and use this information to guide your catheter.

### 7.9 EP cockpit

EP cockpit creates a comfortable EP lab working environment, integrates EP information across the EP care cycle and enables new complex therapies.

The EP cockpit brings the following innovations to your EP lab

- Organize EP equipment on one moveable ceiling mounted rack to reduce EP clutter
- Mix and match images from Philips and 3rd party equipment on any Philips' exam or control room monitor
- Operate equipment (incl 3rd party systems) centrally from one workspot in control room
- Store and retrieve all information used during EP procedure in a central place
- Reduce radiation exposure for staff and patients by up to 80% with special EP X-ray dose settings

### 7.10 ECG triggering

ECG triggering offers the possibility to acquire one fluoroscopic image per heart cycle, each at the same phase (e.g. end-diastolic or end-systolic). Acquiring only one image per cardiac phase has two major advantages:

- Acquiring only one frame per heartbeat drastically reduces patient and physician X-ray dose.
- By acquiring one image at the same cardiac phase each time, cardiac motion is eliminated from the images. This allows the physician to focus on relevant items only (e.g. moving catheters) without the movement caused by the cardiac contraction being visible. For each heartbeat the system generates a trigger pulse and only one image is acquired. Please be aware that ECG triggering needs the Physio Viewing feature.

## Optional

### Ambient Experience

At Philips we consider the total interventional experience and we have created the unique 'ambient experience concept'. Ambient Experience maximizes comfort and minimizes stress for both patients and staff by using a combination of lighting, music and architectural elements to create a uniquely soothing and comfortable environment – in the waiting room, in the procedure room, and in the control room.

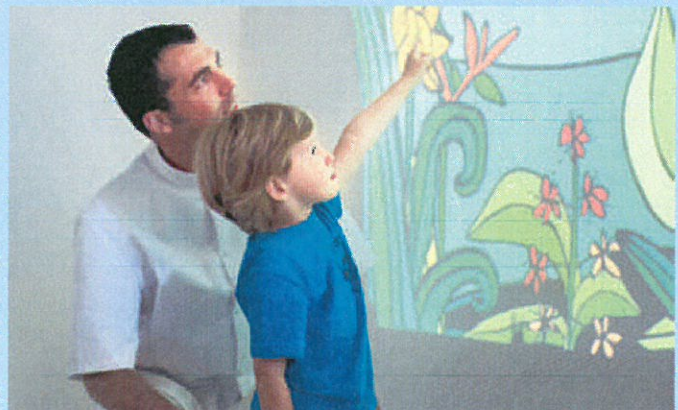

Ambient Experience, a purpose-fully designed environment that makes patients and staff feel more comfortable.



# 8 Integration solutions

The Xper DICOM Image Interface enables clinical images to be exported to a destination, such as ViewForum, Xcelera or any third party PACS. The system exports clinical studies in DICOM XA Multi Frame or DICOM Secondary Capture formats.

The Xper DICOM Image Interface speeds up image transfer through its fast Ethernet link, making images available on-line within seconds. The archiving process can be configured via Xper settings:

- The image archiving is done in the background during or after the procedure
- The images can be archived automatically in the background with the Continuous Autopush option
- The export format is configurable in 512<sup>2</sup>, 1024<sup>2</sup>, or 2k<sup>2</sup> (unprocessed) matrix
- The Xper DICOM Image Interface can distribute the examination images to multiple destinations for archiving and reviewing purposes
- The Xper DICOM Image Interface provides DICOM Store and DICOM Store Commitment Services
- The Query/Retrieve function allows older DICOM studies to be uploaded in the system

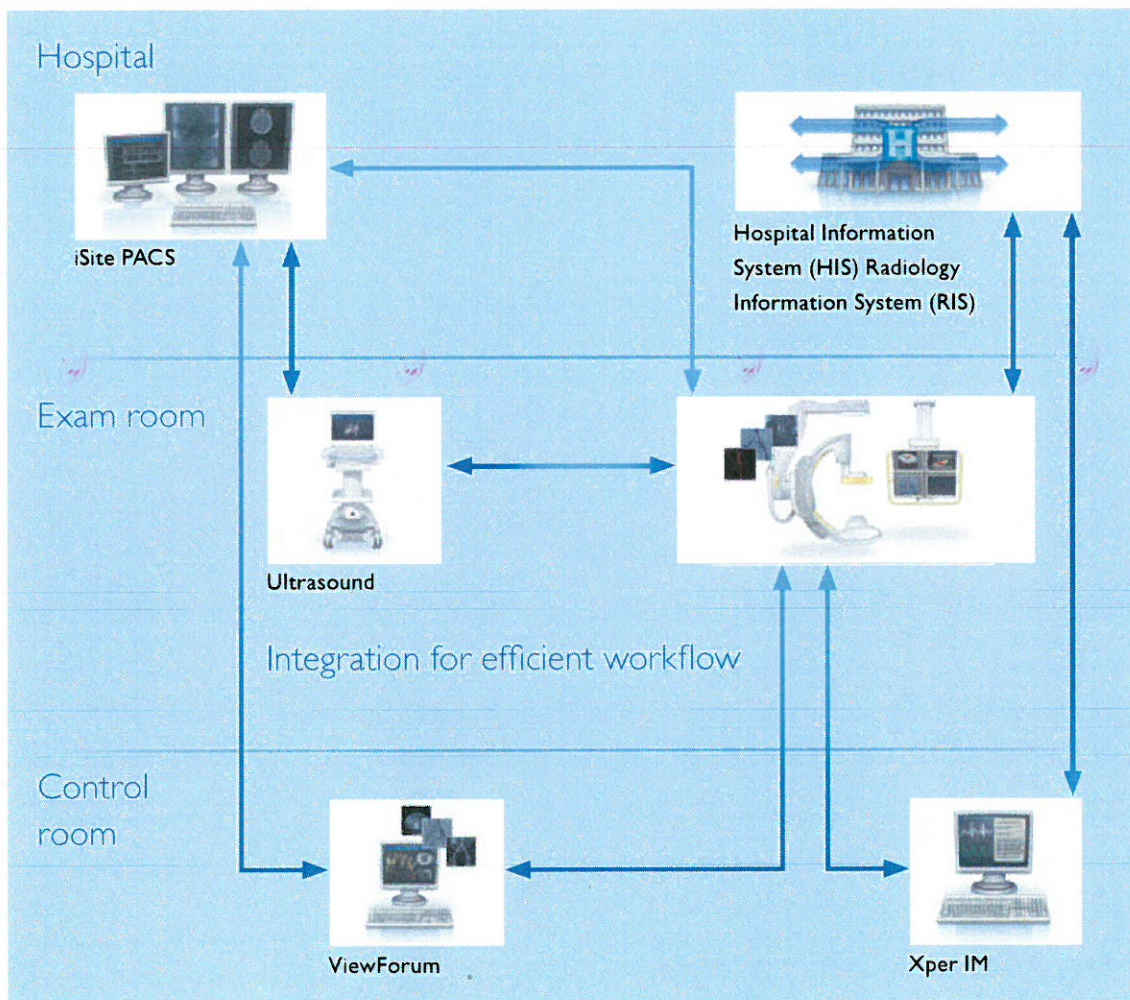

## Optional

### Continuous autopush

This option provides an additional processor board that is dedicated to archiving. This minimizes interruptions that are caused by other functions that require the image processor, such as patient review. Using the continuous autopush option speeds up archiving and availability of clinical images for review at other PACS destinations.

### DICOM Print

DICOM Print provides an interface to any DICOM Printer. It provides Print Preview, Print Compose, Print Manual Overrides, Print Job submission, and Print Job management via automated printing protocols.

### Intercom

The remote Intercom is used for communication between the examination and control room.

### Lab reporting

This option allows the clinical user to generate and print a report in modality stand-alone situations. The user can incorporate free text, clinical images and X-ray dose information. The report is printed or sent by e-mail. Part of the report is generated automatically from administrative data (e.g. patient/exam data, hospital name) and acquired data (e.g. run log, X-ray dose information and event log).

### RIS/CIS DICOM Interface

This interface option enables two-way communication between the FD20 and a local Information System (CIS or RIS) or hemodynamic system. The interface uses the DICOM Worklist Management (DICOM WLM) and Modality Performed Procedure Step (DICOM MPPS) standards. If an information system is present, it is possible to receive patient and examination (request) information and to report examination results.

This option provides the following benefits:

- Eliminates the need to retype patient information on the system
- Can help prevent errors in typing patient name or registration number, which allows for consistency of

information throughout the department to prevent problems in archive clusters

- Provides information to and from the information system about the acquired images and radiation dose. Upon request from the system, the complete worklist with all relevant patient and examination data is returned to the system.

### Standard line rate video output

The standard line rate video output option is 625 (525) lines for a 50 (60) Hz video output unit. This option is required to connect a medical DVD/VCR or an additional TV monitor. This option enables you to store fluoro and acquisition data on a DVD/CD as X-ray is being generated during fluoroscopy and exposure.

### Cath lab experience

The Philips cath lab experience is based on a simple yet powerful concept: The procedures you perform are increasingly complex, so using advanced technologies that assist you in diagnosing and treating your patients should not be. Our offerings for interventional X-ray interventions are designed to simplify cath lab workflow, which can empower you to focus on your patients and may help you to deliver faster, accurate diagnosis and treatment.

With advanced image acquisition and visualization tools, multimodality access, hemodynamic monitoring and integrated reporting, the Philips cath lab experience creates a fluid workflow that works for you and your patients.

### ViewForum

The ViewForum workstation provides a parallel working environment in the angio suite and enables integrated multimodality viewing for interventional procedures, providing guidance to enhance patient care. ViewForum supports an integrated environment by providing access to previously acquired diagnostic data from CT, MR and US, and access and control of multi-modality information in the exam room. Parallel working allows for post-processing of a patient in the control room, while treating the same or another patient in the exam room in order to increase patient throughput and procedure efficiency.

## 9 Services



### Services – a full lifecycle solution

The success of your organization depends on people. Philips Services are designed with that in mind – creating healing environments, developing your staff, improving your organization's performance, and increasing patient satisfaction.

Depend on us. The resources, training, and support we offer enable you to focus on what's most important – your patients.

Philips provides a full lifecycle solution designed around your patients, your people, and your organization. We help you succeed in every phase of system ownership, from planning to start-up, through peak usage and renewal.

### Planning

Understand how and when the right equipment and services contribute to better patient care and better economics.

### Start-up

Make the most of your system as quickly as possible.

### Peak Usage

Extract maximum utility out of your system day to day.

### Renewal

We'll help you make smart decisions on upgrading or transitioning to a new system.



[asimpleswitch.com](http://asimpleswitch.com)

Our Allura Xper FD20 is labeled as being a Green Product. The Allura Xper FD20 saves you at least 12% energy, and 5% is related to the use of LCD monitors. An optimal counter balance design has resulted in eliminating 83% of the total lead content thus reducing the amount of lead to an absolute minimum for specific applications only (e.g. X-ray shielding).



Hazardous substances



Energy efficiency

# 10 Room layout

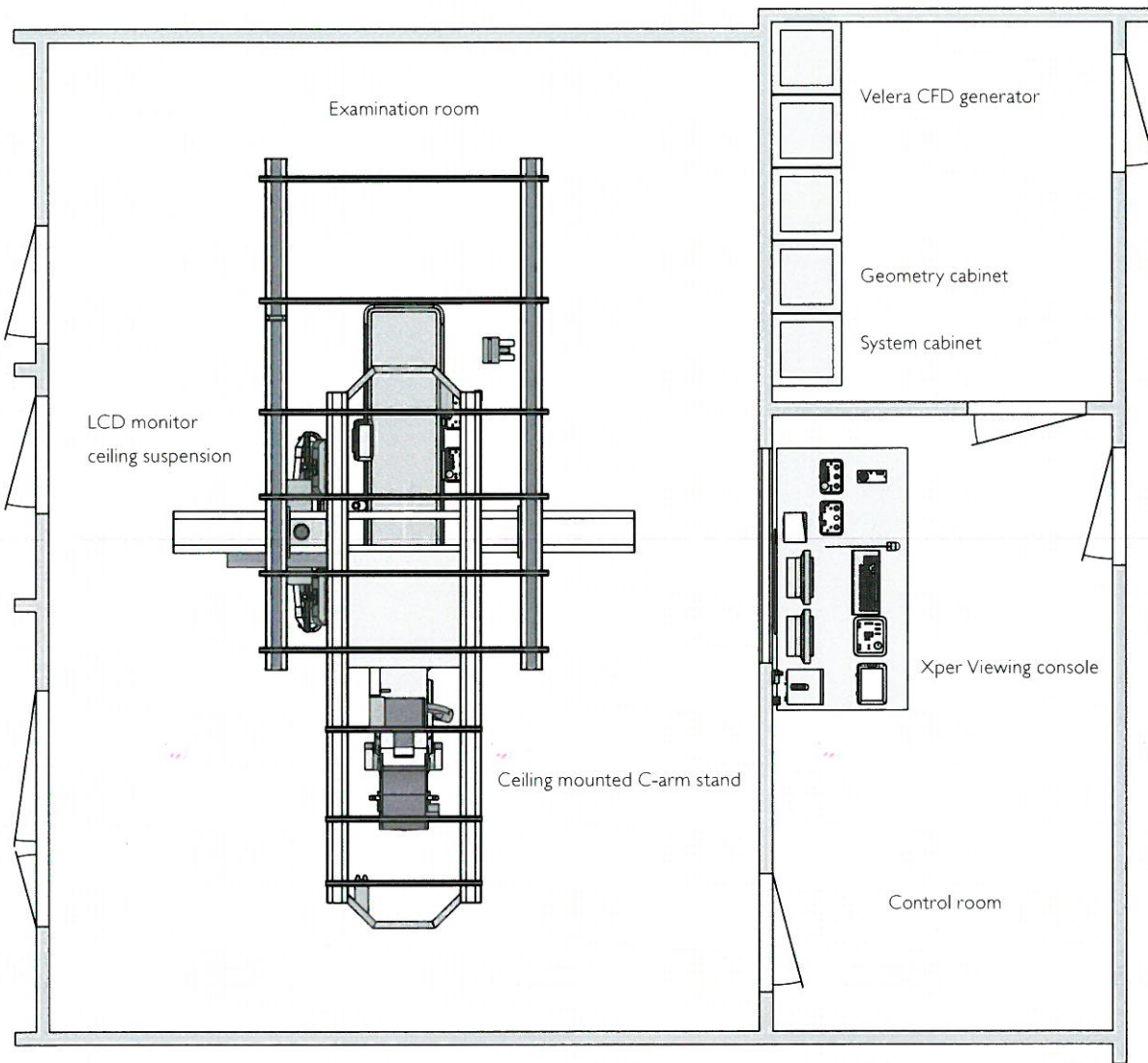

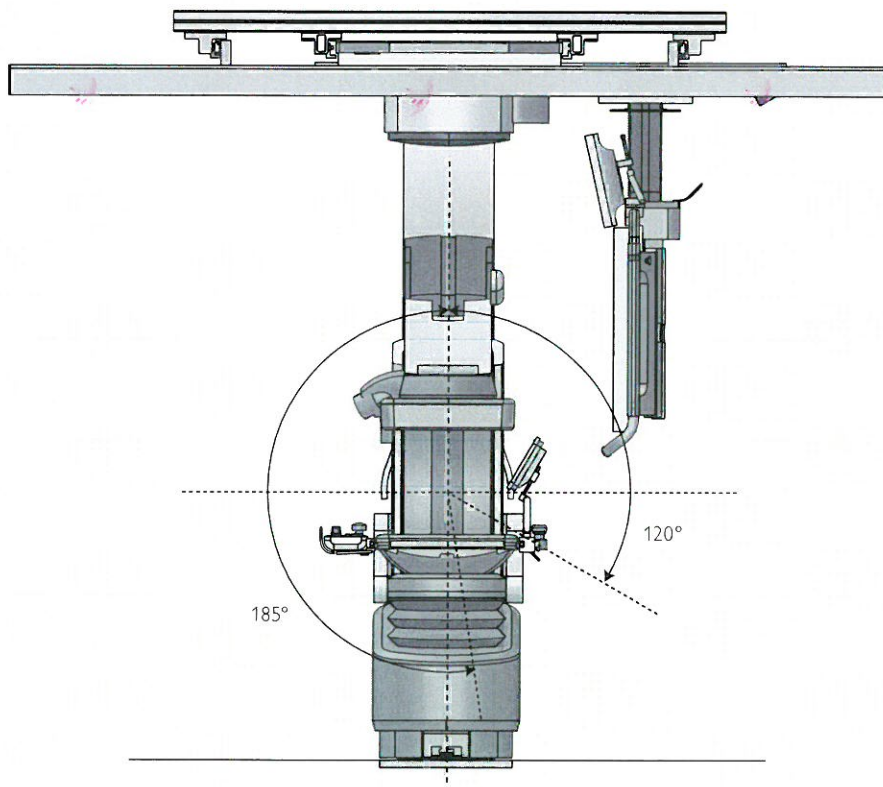
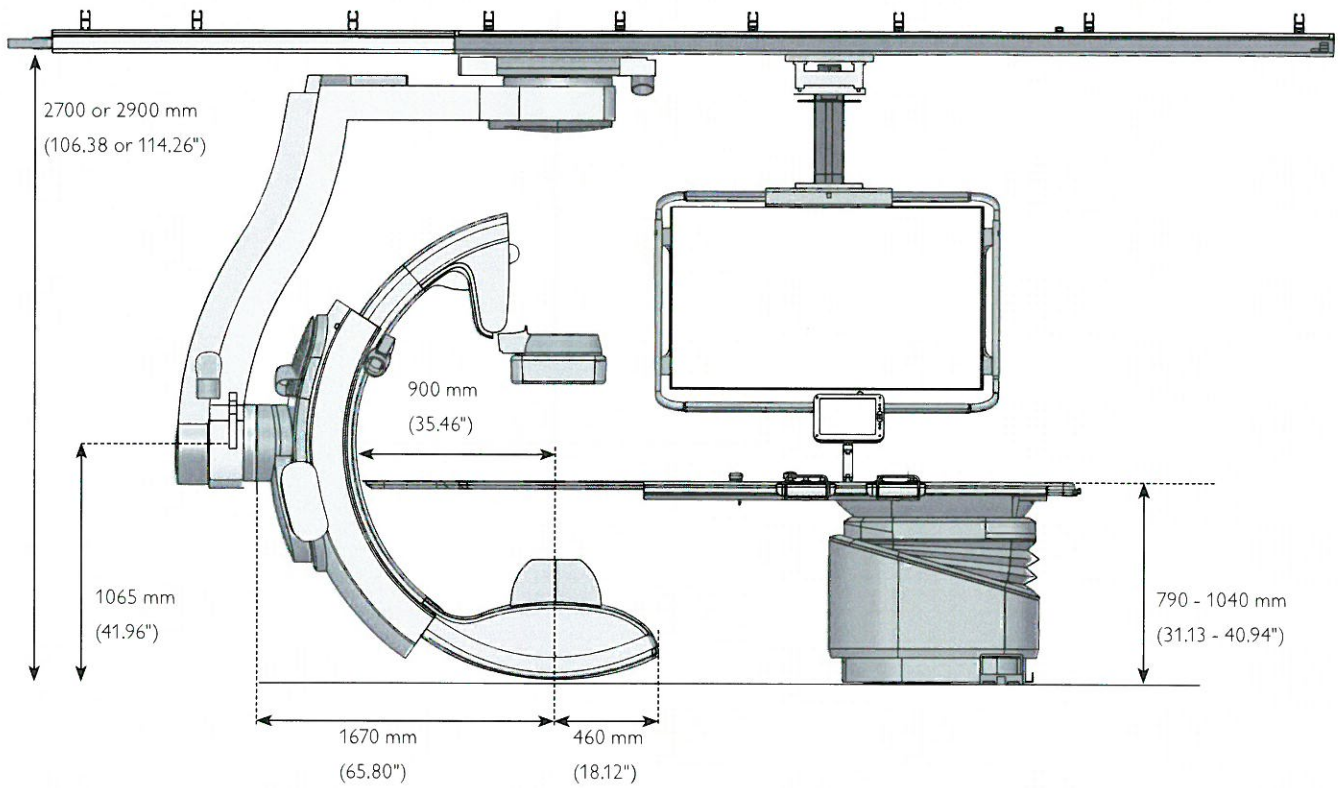

**Philips Healthcare is part of  
Royal Philips Electronics**

How to reach us

[www.philips.com/healthcare](http://www.philips.com/healthcare)

[healthcare@philips.com](mailto:healthcare@philips.com)

fax: +31 40 27 64 887

Asia

+852 2821 5888

Europe, Middle East, Africa

+49 7031 463 2254

Latin America

+55 11 2125 0744

North America

+1 425 487 7000

800 285 5585 (toll free, US only)



[asimpleswitch.com](http://asimpleswitch.com)

Please visit [www.philips.com/interventionalxray](http://www.philips.com/interventionalxray)



© 2010 Koninklijke Philips Electronics N.V.  
All rights are reserved.

Philips Healthcare reserves the right to make changes in specifications and/or to discontinue any product at any time without notice or obligation and will not be liable for any consequences resulting from the use of this publication.

Printed in The Netherlands.  
4522 962 59561 \* JUN 2010

*The print quality of this copy is not an accurate representation of the original.*



PRICING SUPPLEMENT - PURCHASE

Print Date 6/15/17

Master Agreement ID 37777-01  
Pricing Supplement ID 5264899

Summary By Product

Start Date 06/14/17  
Expiration Date 12/30/17  
Price List Carolina Health Sys

Quote: 5264899 CMC Main Cath Lab Reno

Ship To ID 10166  
Carolinas Medical Center  
1000 Blythe Boulevard  
Charlotte NC 28203

Bill To ID 10166  
Carolinas Medical Center  
1000 Blythe Boulevard  
Charlotte NC 28203

Support Services Term / Level 12 Months/Advantage

Product	Description	Qty	Product			Monthly Services	
			Contract List Price	Unit Price	Extended Price	Unit Services	Extended Services
MED-DRW-001	XT 48-BIN OPEN CONFIGURABLE DRW	2	\$1,500.00	\$1,500.00	\$3,000.00		
MED-DRW-005	XT MED 18-BIN METAL LOCKING LID DRW	1	\$3,060.00	\$3,060.00	\$3,060.00		
MED-FRM-104	XT MED 1/2-HEIGHT CABINET	1	\$20,910.00	\$20,910.00	\$20,910.00	\$85.00	\$85.00
	Solution Includes: * XT MED 1/2-HEIGHT CABINET * SW LICENSE- SCHEDULED MEDS * SW LICENSE- PROFILE OPTION * XT SCANNER, WIRED (1/2 & 1/4 HEIGHT) * XT CONSOLE- BIOID, MED LBL & RCPT PRNTR						
OMC-LIC-007	OC REMOTE ACCESS WIN2012 UPG (SILVER)	1	\$3,600.00	\$3,600.00	\$3,600.00	\$173.00	\$173.00
OMC-SFW-040	OMNICENTER VMWARE UPG, BASE, WIN2012	1	\$5,500.00	\$5,500.00	\$5,500.00	\$213.00	\$213.00
	Customer acknowledges and agrees to comply with all provisions of the Server Virtualization Minimum Requirements policy document which is available upon request.						
SRD-OPT-012	XT FLEXLOCK WITH 50 FT CABLE,INSTALLED	1	\$2,370.00	\$2,370.00	\$2,370.00	\$20.00	\$20.00
			<b>Total Product</b>		\$38,440.00		
			<b>Total Support Services</b>		\$5,892.00		
			<b>Total Shipping &amp; Handling</b>		\$853.00		

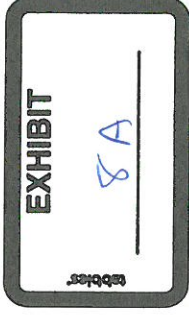



PRICING SUPPLEMENT - PURCHASE

Print Date 6/15/17

Product	Description	Qty	Contract		Product		Monthly Services	
			List Price	Unit Price	Unit Price	Extended Price	Unit Services	Extended Services
							\$45,185.00	
			<b>Grand Total</b>					

A purchase order for Support Services in the amount shown as Total Service Fees is included with this Pricing Supplement.

Omnicell shall not be liable for any delays in the provision of Support Services if Omnicell is unable to obtain access to the Delivered Product due to a Customer provided padlock on the Omnicell Padlock Cabinet Kit.





**PRICING SUPPLEMENT - PURCHASE**

**Print Date** 6/15/17

**Master Agreement ID** 37777-01

**Supplement**

**Start Date** 06/14/17

**Pricing Supplement ID** 5264899

**Expiration Date**

**Quote:** 5264899 CMC Main Cath Lab Reno

**Price List** Carolina Health Sys

**Ship To ID** 10166

**Bill To ID** 10166

Carolinas Medical Center  
1000 Blythe Boulevard  
Charlotte NC 28203

Carolinas Medical Center  
1000 Blythe Boulevard  
Charlotte NC 28203

**Support Services Term / Level** 12 Months/Advantage

1. This Pricing Supplement is subject to and incorporates by reference all of the terms and conditions as set forth within the Master Agreement identified above.
2. Any terms and conditions on any Purchase Order issued in conjunction with this Pricing Supplement shall be for reference purposes only and shall not become a part of the terms and conditions of this Pricing Supplement.
3. Customer acknowledges and agrees that it is Customer's obligation to pay the amounts as set forth on this Pricing Supplement and that such payment obligations are governed by the terms and conditions of the above referenced Master Agreement including all applicable scheduled, attachments and exhibits.
4. The undersigned hereby acknowledges that he/she has the authority to sign this Pricing Supplement and bind the Customer to the terms and conditions of this Pricing Supplement.

<p><b>OMNICELL, INC:</b></p> <p>Signature: _____</p> <p>Print Name: _____</p> <p>Title: _____</p> <p>Date: _____</p>	<p><b>CUSTOMER:</b></p> <p>Signature: _____</p> <p>Print Name: _____</p> <p>Title: _____</p> <p>Date: _____</p>
--	---

**\*\* Please fax all document pages to (650) 251-6240**

Attn: Sales Operations  
Omniceil, Inc.  
590 E. Middlefield Road  
Mountain View, CA 94043  
Phone: (650) 251-6000  
Fax: (650) 251-6240



**PRICING SUPPLEMENT - PURCHASE**

**Print Date** 6/15/17

**Master Agreement ID** 37777-01

**Summary - Service Only**

**Start Date** 06/14/17

**Pricing Supplement ID** 5264899

**Expiration Date** 12/30/17

**Quote:** 5264899 CMC Main Cath Lab Reno

**Price List** Carolina Health Sys

**Ship To ID** 10166

**Bill To ID** 10166

Carolinas Medical Center  
1000 Blythe Boulevard  
Charlotte NC 28203

Carolinas Medical Center  
1000 Blythe Boulevard  
Charlotte NC 28203

**Support Services Terms / Level** 12 Months/Advantage

Product	Description	Qty	Unit Services	Extended Services
MED-FRM-104	XT MED 1/2-HEIGHT CABINET	1	\$85.00	\$85.00
OMC-LIC-007	OC REMOTE ACCESS WIN2012 UPG (SILVER)	1	\$173.00	\$173.00
OMC-SFW-040	OMNICENTER VMWARE UPG, BASE, WIN2012	1	\$213.00	\$213.00
SRD-OPT-012	XT FLEXLOCK WITH 50 FT CABLE,INSTALLED	1	\$20.00	\$20.00
<b>Total Support Services</b>				<b>\$5,892.00</b>

Par Location:  
Cath Lab

Options

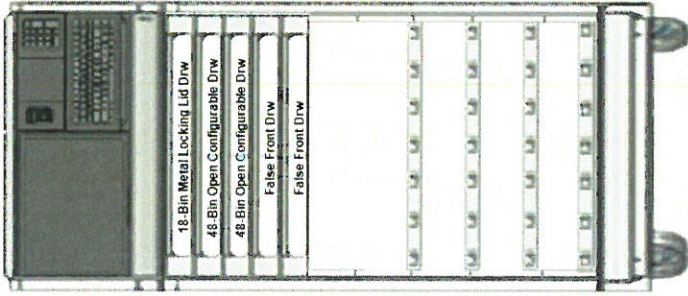

<b>CONSOLE w/ Bond, Med Label &amp; Receipt Printer</b> <b>Hardware:</b> -Scanner, Wired <b>Software:</b> -Profile Option -Scheduled Alerts <b>FlexLock with 50 ft cable</b> Factory Install Kit 7.5"W x 14.4"D x 5.5"H
---

- 18-Bin Metal Locking Lid Drw
- 48-Bin Open Configurable Drw
- 48-Bin Open Configurable Drw
- False Front Drw
- False Front Drw

10 RU

**MED-FRM-104**  
XT MED 1/2-Height Cabinet  
Dimensions: 26.5"W x 54"H x 27"D

**Avoximeter® Quotation**

**Account Name / Number:** Carolinas Medical Center- Main  
**GPO/IDN:** Carolina Shared Services  
**Address:** 1000 Blythe Blvd,  
**City, State, Zip Code:** Charlotte, NC 28203  
**Contact Person:** Stephanie Tilson  
**Phone Number:** 704-213-5218  
**Email Address:** [stephanic.tilson@am.jll.com](mailto:stephanic.tilson@am.jll.com)  
**Accriva Sales Rep:** Susan Jones  
**Email Address:** [sjones@ilww.com](mailto:sjones@ilww.com)  
**Phone Number:** 919-280-5174

**Placing an Order With Accriva Diagnostics**

**Send To:**  
 Accriva Diagnostics  
 Attn: Customer Service Department  
 6260 Sequence Drive | San Diego, CA 92121  
 Phone: 800-643-1640  
 Fax: 858-314-6701  
 e-mail: [customerservice@accriva.com](mailto:customerservice@accriva.com)

Date Of Quotation	Quotation Expiration Date	Payment Terms	F.O.B. Origin Unless Otherwise Shown	Quotation Number		
7/24/17	12/30/2017	NET 30 DAYS	ORIGIN			
Qty.	Product Code	Product Code and Description		2017 Price	Discount	Extended Price
1	AVOX4000	<b>Avoximeter 4000</b> Avoximeter 4000 - System w/ Power Supply 110-220V; includes: Operator's manual, AC adapter, cord, optical filters and one year warranty, (1 ea)		\$8,950.00		\$8,950.00
1	AVOXPRNT	<b>Printer for the Avoximeter 1000E and Avoximeter 4000, (1ea)</b>		\$495.00		\$495.00
1	WAVOX1	<b>Extended Warranty Plan</b> Extended Warranty Plan for the Avoximeter 1000E and 4000. Price per instrument per year of warranty extension. (1 ea)		\$850.00		\$850.00
<b>Total Quotation for Instruments , Printer, and Extended Warranty</b>						<b>\$10,295.00</b>

PRICES QUOTED ARE NOT VALID UNTIL A VALID PO IS RECEIVED AND IS ACCEPTED BY ACCRIVA DIAGNOSTICS; SHIPMENT OF PRODUCT AGAINST PO WILL CONSTITUTE ACCEPTANCE ON BEHALF OF ACCRIVA

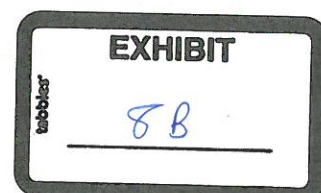

# Proposal

June 15, 2017

Rino Bevis  
 rino.bevis@stryker.com

**Submitted To:**

CAROLINAS MED CTR  
 Attn: Chris Hollar

Note:  
 Chris,

This proposal includes our F528 Surgical light and HD In Light Surgical Camera for the EP Lab Renovation at CMC Main.

CHS/Stryker Terms



## STRYKER ISUITE



## BERCHTOLD® F-GENERATION SURGICAL LIGHT

The BERCHTOLD line of surgical lights carry on a legacy of surgical lighting innovation by combining proven reflector technology with the latest breakthrough in LED lens technology. These surgical lights boast four color temperature settings, full 360 degree rotation and Precision Beam Technology(TM) that focuses 650 beams of overlapping light into one homogenous column, creating ideal light quality and shadow prevention.

PART #	DESCRIPTION	QTY
	F 528	1
	<b>Configuration Details:</b>	
	Suspension: Single	
	Controls: Wall mounted (surface mount)	
	Tube Length: 180	
	Handle Type: Devon screw on	
	Electronics: Yes	
	<b>MP1:</b>	F 528
	Arm Length: 1100	
	Cardanic Style: Classic	

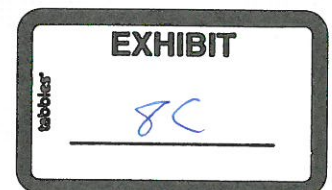

FS 1001	F528 Surgical Light	1
CY 9600105	Preparation Camera StrykeCam HD	1
CY 1008104	Multi Color Touch wall control display f	1
CY 7000600	Preparation for communication interface,	1
P31858	STRYKECAM HD FOR F-GEN	1

---

P22059	HI-DEF CAMERA DECODER ASSEMBLY	1
100224637	CABLE ASSY DVI M TO DVI M 15 FT	1
P30340	HD CAMERA EXT CI BOX	1
74729	Cable Set, Canbus 15m (50ft) 4-Wire	1
83308	Handle, Devon Screw-on (E, Weighted)	1

---

---

## ISUITE INSTALLATION AND SERVICE

PART #	DESCRIPTION	QTY
RS 0006008	Installation, Chromophare	1

Total List Price

\$76,627.45

# Proposal

June 28, 2017

Rino Bevis  
 rino.bevis@stryker.com

**Submitted To:**

CAROLINAS MED CTR  
 Attn: Chris Hollar

Chris,  
 Please find the Stryker Video Integration system for the CMC EP Lab to include:  
 SPI-3 Video Integration System  
 19" Touch Panel Control  
 HD PTZ Camera  
 2-55" Wall Displays  
 Video Connection Ports  
 Interface with Phillips System  
 Cabling  
 Project Management and Installation

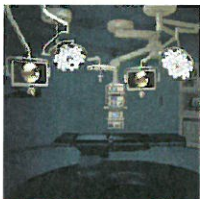

## STRYKER ISUITE

Stryker iSuite

PART #	DESCRIPTION	QTY
--------	-------------	-----



## SPI3

This all-in-one HD digital video routing system supports all video standards and resolutions including 1080P and up to 1200P. The SwitchPoint Infinity 3 offers a platform tailored specifically to each individual operating room, providing efficiency and flexibility during surgical procedures.

PART #	DESCRIPTION	QTY
0678001000	PKG, SWITCHPOINT INFINITY 3	1

## SPI3 ACCESSORIES

SPI3 Accessories

PART #	DESCRIPTION	QTY
<b>SPI3 ACCESSORIES-COMPONENTS</b>		
<b>SPI3 Accessories-Components</b>		
0100222791	MOUNT, FLUSH BRACKET	1
0100222551	7 MOUNTING CHANNEL FOR PIVOT	1
0100222910	PLATE, HD-15 AND DB9, 1 GANG	1
0678001017	PKG, SPI3, PTZ CAMERA SYSTEM, HD	1
0100222909	PLATE, HD-15, 1 GANG HD15	2
0678001060	PACKAGE, DVI WALL PLATE, COPPER, PASSIVE, 75FT	2
0100224158	MOUNT PLATE PLASMA/LCD	2
0678001223	PKG, LCD MONITOR 55 INCH W/O CABLES	2
0100224181	ASSY PLATE 1 GANG 1.5 HOLE	2

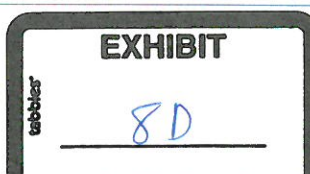



SPI3 ACCESSORIES-CABLING		SPI3 Accessories-Cabling	
0680000182	CABLE KIT SHAPE ARM TPM		1
0100000665	CABLE, M HD-15 TO 5 M BNC, 75		2
0100224468	CABLE ASSY, RUGGED FIBER OPTIC DVI		9

### ISUITE INSTALLATION

iSuite Installation

PART #	DESCRIPTION	QTY
<b>ISUITE INSTALLATION</b>		
8888888201	INSTALLATION ORIS-SPI3	1

### SERVICE AND INSTALL

PART #	DESCRIPTION	QTY
<b>PREINSTALL MANUALS</b>		
<b>Pre-Install Manuals</b>		
1004400059	OPERATING ROOM INFORMATION SYSTEM PRE-INSTALLATION MANUAL	1
<b>ENGINEERING SERVICES</b>		
8888888900	PROJECT SERVICES	1
8888888401	INSTALLATION-IMPLEMENTATION STAGING CHARGE	3

### Additional Parts

PART #	DESCRIPTION	QTY
0100000715	DA VGA 6 OUTPUT	4
0100224099	DVI SPLITTER	4
0680000215	CABLE KIT, DVI-I TO DVI-I/HD-15 3'	6
0100000665	CABLE, M HD-15 TO 5 M BNC, 75	4

Communications List Price **\$158,036.67**

THE PRICING OFFERED HEREIN IS EXCLUSIVE TO THE CUSTOMER SET FORTH IN THIS PROPOSAL AND IS CONFIDENTIAL AND PROPRIETARY TO STRYKER. CUSTOMER AGREES TO NOT DISCLOSE SUCH PRICING TO ANY THIRD PARTIES, INCLUDING BUT NOT LIMITED TO ANY ON-LINE DISCOUNTING WEBSITES OR FORUMS. UNLESS OTHERWISE STATED IN THIS PROPOSAL CUSTOMER UNDERSTANDS THAT THIS PRICING IS ONLY VALID FOR CURRENT PURCHASES, AND ALL PRICING FOR SUBSEQUENT PURCHASES WILL BE NEGOTIATED AT A LATER DATE.

\_\_\_\_\_  
 Stryker Representative Signature

\_\_\_\_\_  
 Authorized Customer Signature

**EQUIPMENT COMPARISON**

	Existing Equipment	Replacement Equipment
Type of Equipment (List each component)	Cath Angio	Cath Angio
Manufacturer of Equipment	Philips	Philips
Tesla Rating for MRIs	N/A	N/A
Model Number	Integris Allura 15	Allura Xper FD 10
Serial Number	4800590/002842	Not Available Until Installed
Provider's Method of Identifying Equipment	CHS Asset # / Serial #	CHS Asset # / Serial #
Specify if Mobile or Fixed	Fixed	Fixed
Mobile Trailer Serial Number/VIN #	N/A	N/A
Mobile Tractor Serial Number/VIN #	N/A	N/A
Date of Acquisition of Each Component	Summer 2002	Winter 2018
Does Provider Hold Title to Equipment or Have a Capital Lease?	Title	Title
Specify if Equipment Was/Is New or Used When Acquired	New	New
Total Capital Cost of Project (Including Construction, etc.) <Use Attached Form>	\$2,629,379	\$1,962,116
Total Cost of Equipment <sup>1</sup>	\$1,287,077	\$862,280
Fair Market Value of Equipment	\$49,100	\$862,280
Net Purchase Price of Equipment	\$1,287,077	\$862,280
Locations Where Operated	CHS University 8800 N Tryon St Charlotte, NC 28262	CMC 1000 Blythe Blvd Charlotte, NC 28203
Number Days in Use/To Be Used in N.C. per Year	253	253
Percent of Change in Patient Charges (by procedure)	None	None
Percent of Change in Per Procedure Operating Expenses (by procedure)	None	None
Type of Procedures Currently Performed on Existing Equipment	Electrophysiology (EP), Cardiac Cath	N/A
Type of Procedures New Equipment is Capable of Performing	N/A	Electrophysiology (EP)

<sup>1</sup> Equipment cost includes only the equipment.

## Hale, Gloria

---

**From:** Qualls, Gary <Gary.Qualls@klgates.com>  
**Sent:** Wednesday, September 27, 2017 4:24 PM  
**To:** Frisone, Martha  
**Cc:** 'Elizabeth.Kirkman@carolinashealthcare.org'; Hale, Gloria; Pittman, Lisa  
**Subject:** CMHA's Supplemental Clarifying Information Regarding September 7, 2017 Filing

Martha:

1. Your recitation of Step #1 is accurate.
2. I would tweak your Step #2 recitation slightly to say:

Step 2: The existing unit of equipment at University that was used to provide the cardiac catheterization services (i.e., the Philips Integris Allura 15 Model) will be removed by the Vendor and rebuilt using the base part of that Allura 15 Model. Using that Allura 15 Model base, the rebuilt equipment will be a Philips Allura Xper FD 10 Model with a different serial number (See Ex. 9 to my September 7 Filing). That rebuilt equipment will be installed in Room 1 at CMC where it will be used to provide EP services.

3. You are also correct that “There will be no net increase in the number of units of cardiac catheterization equipment or EP equipment owned and operated by The Charlotte-Mecklenburg Hospital Authority in Mecklenburg County.”

Let me know if you any follow-up questions.

Thanks

Gary

---

**From:** Frisone, Martha [<mailto:martha.frisone@dhhs.nc.gov>]  
**Sent:** Wednesday, September 27, 2017 11:20 AM  
**To:** Qualls, Gary; 'Elizabeth.Kirkman@carolinashealthcare.org'  
**Cc:** Hale, Gloria; Pittman, Lisa  
**Subject:** RE: CMHA's Supplemental Clarifying Information Regarding September 7, 2017 Filing

Thanks, Gary. However, your clarification does not appear consistent with our understanding of the proposal. Please confirm that the following accurately explains the proposal:

Step 1: Change the site of the existing cardiac catheterization services (1 unit of cardiac catheterization equipment) currently located at Carolinas Health System University (University) to Carolinas Medical Center (CMC) by using an existing EP unit located in Room 8 at CMC.

Step 2: The existing unit of equipment at University that was used to provide the cardiac catheterization services will be removed by the Vendor, rebuilt and the rebuilt equipment will be installed in Room 1 at CMC where it will be used to provide EP services.

In Step #2 above, once the Replacement EP Equipment is installed at CMC in Cardiology Room 1, CMHA will dispose of the Existing EP Equipment by conveying that Existing EP Equipment to Philips for scrap use or resale outside of North Carolina absent subsequent CON approval.

Let me know if you have any questions.

Thanks

Gary



**Gary S. Qualls**

Partner

K&L Gates LLP

430 Davis Drive, Suite 400

Morrisville, NC 27560

Phone: 919-466-1182

Fax: 919-516-2072

[gary.qualls@klgates.com](mailto:gary.qualls@klgates.com)

[www.klgates.com](http://www.klgates.com)

This electronic message contains information from the law firm of K&L Gates LLP. The contents may be privileged and confidential and are intended for the use of the intended addressee(s) only. If you are not an intended addressee, note that any disclosure, copying, distribution, or use of the contents of this message is prohibited. If you have received this e-mail in error, please contact me at [Gary.Qualls@klgates.com](mailto:Gary.Qualls@klgates.com).

---

Email correspondence to and from this address is subject to the North Carolina Public Records Law and may be disclosed to third parties by an authorized State official. Unauthorized disclosure of juvenile, health, legally privileged, or otherwise confidential information, including confidential information relating to an ongoing State procurement effort, is prohibited by law. If you have received this email in error, please notify the sender immediately and delete all records of this email.

This electronic message contains information from the law firm of K&L Gates LLP. The contents may be privileged and confidential and are intended for the use of the intended addressee(s) only. If you are not an intended addressee, note that any disclosure, copying, distribution, or use of the contents of this message is prohibited. If you have received this e-mail in error, please contact me at [Gary.Qualls@klgates.com](mailto:Gary.Qualls@klgates.com).